



Kutije, kućišta i razvodne table

Boxes, Enclosures and Consumer Units

392



Ave opremu mora da instalira obučeno lice, a tehničku ispravnost sistema mora da proverí stručno lice, u skladu sa važećim propisima
Ave material must be installed by qualified people and the plant must be tested by an expert; according to regulations in force

Ugradne kutije za elektrogalanteriju

394

Flush mounted boxes for wiring accessories

Multifunkcionalne ugradne razvodne kutije

399

Multifunction junction boxes

Ugradne razvodne table IP40 / IP55

404

IP40 / IP55 flush mounted consumer units

Ugradne podne kutije

406

Outlet Socket Boxes

Nadgradne kutije i kućišta za kanalice i mini kanalice

408

Enclosures and Consumer Units for Trunkings and Mini Trunkings

Nadgradne razvodne table IP40 / IP55 / IP65



413

IP40 / IP55 / IP65 wall mounted consumer units

Dodatna oprema

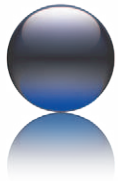

415

Accessories

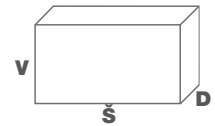

Ugradne kutije za elektrogalanteriju

Flush Mounted Boxes for Wiring Accessories



Ugradne kutije za pune zidove - plava RAL 5017

Boxes for brickwork walls - RAL 5017 blue

394



2501

2502



2503MG

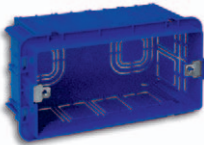

2504

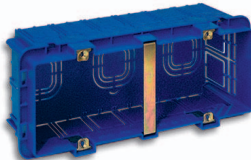

2506

Kod Code	Opis Description	Info	€
2501	Okrugla kutija za 1-2 modula S44 i S45 - dimenzije (Ø - Ø unutrašnji P): 72x60x50 mm 1-2 modules S44 and S45 round box - dimensions (Ø - Ø internal D): 72x60x50 mm	450	450
2502	Kvadratna kutija za 1-2 modula S44 i S45 - rastojanje između šrafova 60 mm - može se spajati - dimenzije (Š V D): 73x73x42 mm 1-2 modules S44 and S45 square box - screws fixing centres 60 mm - it can be coupled dimensions (L H D): 73x73x42 mm	50	50
2503MG	Pravougaona kutija za 3 modula S44 i S45 - rastojanje između šrafova 83,5 mm - dimenzije (Š V D): 112x74x53 mm 3 modules S44 and S45 oversized rectangular box - screws fixing centres 83,5 mm dimensions (L H D): 112x74x53mm	300	300
2504	Pravougaona kutija za 4 modula S44 i S45 - rastojanje između šrafova 108,5 mm - dimenzije (Š V D): 137x74x53 mm 4 modules S44 and S45 oversized rectangular box - screws fixing centres 108,5 mm dimensions (L H D): 137x74x53 mm	7	140
2506	Pravougaona kutija za 6 modula S45 ili za 7 modula S44 - horizontalno rastojanje između šrafova 100 mm i vertikalno 57,5 mm - dimenzije (Š V D): 187x74x53 mm 6 modules S45 and 7 modules S44 oversized rectangular box - screws fixing centres horizontal 100 mm and vertical 57,5 mm - dimensions (L H D): 187x74x53 mm	8	120

Napomena: ✓ armature koje se koriste za uređajima iz Sistema 44 str. 170 i iz Sistema 45 str. 278

Note: ✓ coupleable frames System44 page 170 and System45 page 278

Dodatna oprema za ugradne kutije - puni zidovi - plava RAL 5017

Accessories for flush mounted boxes - brickwork walls - RAL 5017 blue

Kod Code	Opis Description	Info	€
BLAS1	Oprema za spajanje ugradnih kutija: BL01P/BL05P/BL06P/BL07P/BL08P/BL08LP/BL09P/BL10S/BL18S/53S36 Coupler for boxes: BL01P/BL05P/BL06P/BL07P/BL08P/BL08LP/BL09P/BL10S/BL18S/53S36	20	20
BLAS2	Oprema za spajanje ugradnih kutija: 2503MG/2504/2506/BL02P/BL03P/BL04P Coupler for boxes: 2503MG/2504/2506/BL02P/BL03P/BL04P	20	20
BLAS25	Oprema za spajanje ugradnih kutija: 2503MG/SFM3/2504/2506/BL02P/BL03P/BL04P Coupler for boxes: 2503MG/SFM3/2504/2506/BL02P/BL03P/BL04P	20	20
BLAS35	Oprema za spajanje ugradnih kutija: 2503MG/SFM3/2504/2506/BL02P/BL03P/BL04P Coupler for boxes: 2503MG/SFM3/2504/2506/BL02P/BL03P/BL04P	20	20
2503PM	Zaštita prilikom krećenja za kutije 2503MG (1 komad) - 2504 (2 komada) - 2506 (2 komada) Mortar-proof cover for boxes 2503MG (1 piece) - 2504 (2 pieces) - 2506 (2 pieces)	140	140
25GS	Rezervne metalne kukice za kutije od 3 i 4 modula Spare metallic hooks for 3 and 4 modules boxes	10	10
2500S	Razdelnik za kutije 2503MG-2504-2506 Clip-in divider for boxes 2503MG - 2504 - 2506	50	50
2575	Poklopac Ø 75mm sa žabicama za okruglu ugradnu kutiju 2501 Ø 75mm lid with clips for 2501 round box	50	50
LIVELAVE	Mini libela za ugradne kutije BL02CG-BL06P-BL07CG-BL07CGN-BL08CGN-BL08LCGC-BL09CGC SFM3-BL18S-BL18CG-BL18TS04-BL18CGTS04-SFM3/HP-SFM3CG-SFM3CG/HP Spirit level for boxes BL02CG-BL06P-BL07CG-BL07CGN-BL08CGN-BL08LCGC-BL09CGC SFM3-BL18S-BL18CG-BL18TS04-BL18CGTS04-SFM3/HP-SFM3CG-SFM3CG/HP	5	5

Nota: ✓ BLAS25 ne treba koristiti sa maskama "Vera" S44 i S45 koje su spojene vertikalno
Note: ✓ BLAS25 can not be used with "Vera" S44 and S45 front plates vertically superimposed



BLAS1



BLAS25



BLAS35



25GS



2503PM



Za raspoloživost kontaktirajte Ave distributere
For availability please contact sales dept.



Dostupni dok se ne rasprodaju zalihe
Available until stock out



Proizvod 2 modula pogodan za okruglu kutiju
2 modules product suitable for round box



Proizvod za pravougaone kutije britanskog standarda
Product for British standard rectangular box



Proizvod za izvoz
For Export only

Specijalne ugradne kutije za instalaciju u ravni sa zidom Special boxes for wall-lined installation

PATENTIAVE N° 209
AVE PATENTS N° 209

Kod Code	Opis Description	Info	€
SFM3	Ugradna kutija za 3 modula za pune zidove - rastojanje između šrafova 83,5 mm - isporučuje se sa zaštitnim kartonom i sa libelom (koji su postavljeni na kutiju) i sa bojivim okvirom (koji je u ravni sa zidom) - u kompletu sa armaturom za 3 modula Sistema 44 3 modules box for brickwork walls - screw fixing centre 83,5 mm - supplied with mortarproof cardboar, spirit level (attached to the box) and paintable frame (leant against the wall) and "System 44" 3 modules frame	2	2
SFM3/HP	Ugradna kutija za 3 modula za pune zidove - rastojanje između šrafova 83,5 mm - isporučuje se sa zaštitnim kartonom i sa libelom (koji su postavljeni na kutiju) i sa armaturom za 3 modula Sistema 44 3 modules box for brickworks walls - screw fixing centre 83,5 mm - supplied with cardboard mortarproof, spirit level (attached to the box) and System 44 3 modules frame	1	1
CRFM3GSL	Rezervni unutrašnji okvir sjajne tamnosive boje (Life 44) - 3 modula Spare inner frame - polished dark grey colour (Life 44) - 3 modules	2	10

Napomena: kutija + maska "Ave Touch" garantuju stepen zaštite IP44
Note: the box with the "Ave Touch" front plate guarantees an IP44 protection degree

Dimenzije Overall dimensions



SFM3/HP



CRFM3GSL

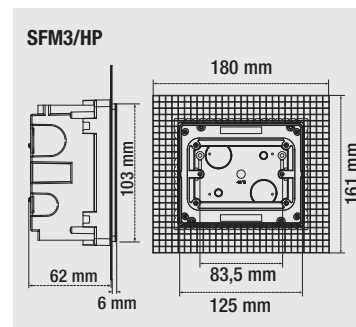
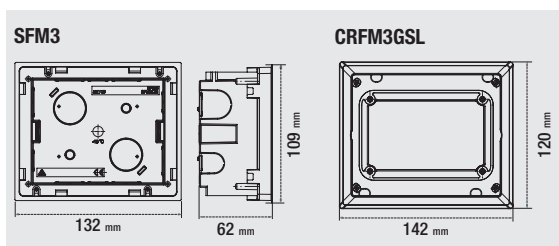

SFM3 Ugradna kutija za zidove od cigle

SFM3 BOX FOR BRICKWORK WALLS



- 1 **Napravite otvor u zidu i pomoću maltera pričvrstite kutiju u horizontalnom položaju, koristeći za nivelisanje priloženu libelu.**

Make the hole and use the supplied level to fix the box



- 2 **Nanesite malter (ne postavljajte unutrašnji okvir)**

Apply the mortar (do not install the inner frame)



- 3 **Poravnajte završni sloj maltera (ne postavljajte unutrašnji okvir)**

Put the finishing touches (do not install the inner frame)

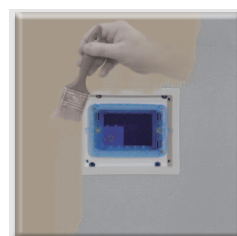

- 4 **Postavite okvir na kutiju i nakon toga obojite zid zajedno sa okvirom**

Install the inner frame, and after, paint the wall and the inner frame



- 5 **Postavite masku**

Place the finishing front plate

SFM3/HP Kutija za zidove od cigle

SFM3/HP BOX FOR BRICKWORK WALLS

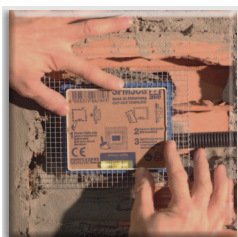

- 1 **Napravite otvor u zidu i pomoću maltera pričvrstite kutiju u horizontalnom položaju, koristeći za nivelisanje priloženu libelu.**

Make the hole and use the supplied level to fix the box



- 2 **Nanesite malter**

Apply the mortar



- 3 **Poravnajte završni sloj maltera**

Put the finishing touches

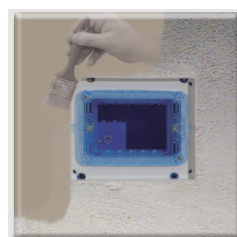

- 4 **Obojite zid**

Paint the wall

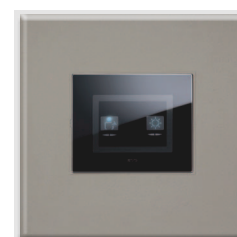

- 5 **Postavite masku**

Place the finishing front plate

◇ Proizvod za kvadratnu kutiju
Product for British Standard square box only

② Proizvod 1 modula koji se može postaviti u okruglu kutiju sa drugim proizvodom 1 modula
1 module product installable in round box with another 1 module device

□ Mln. pakovanje kom.
Min. Packaging pcs

□ Stand. pakovanje kom.
Std. Packaging pcs

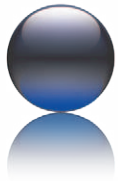

Ugradne kutije za elektrogalanteriju

Flush Mounted Boxes for Wiring Accessories

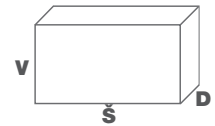

Ugradne kutije za gipskartonske zidove - plava RAL 5017

Boxes for hollow walls - RAL 5017 blue

PATENTI AVE N° 232 AVE PATENTS N° 232

396



253CGPR



253CG



254CGPR



254CG

Kod Code	Opis Description	Info	€
251CG	Okrugla ugradna kutija za 1-2 modula S44 i S45 - dimenzije (Ø P): 68x45,5 mm 1-2 modules S44 and S45 round box - dimensions (Ø P): 68x45,5 mm		40 40
253CGPR	Pravougaona ugradna kutija za 3 modula S44 i S45 smanjene dubine - rastojanje između šrafova 83,5 mm - dimenzija (V Š D): 113x70x45,5 mm 3 modules S44 and S45 rectangular box with reduced depth - screws fixing centres 83,5 mm - dimensions (L H D): 113x70x45,5 mm		180 180
253CG	Pravougaona ugradna kutija za 3 modula S44 i S45 - rastojanje između šrafova 83,5 mm - dimenzije (V Š D): 109x70x51 mm 3 modules S44 and S45 rectangular box - screws fixing centres 83,5 mm - dimensions (L H D): 109x70x51 mm		225 225
254CGPR	Pravougaona ugradna kutija za 4 modula S44 i S45 smanjene dubine - rastojanje između šrafova 71 mm - dimenzija (V Š D): 138x69x45,5 mm 4 modules S44 and S45 rectangular box with reduced depth - screws fixing centres 71 mm - dimensions (L H D): 138x69x45,5 mm		100 100
254CG	Pravougaona ugradna kutija za 4 modula S44 i S45 - rastojanje između šrafova 108,5 mm dimenzije (V Š D): 132x70x51 mm 4 modules S44 and S45 rectangular box - screws fixing centres 108,5 mm dimensions (L H D): 132x70x51 mm		120 120
256CG	Pravougaona ugradna kutija za 6 modula S45 i za 7 modula S44 - rastojanje između šrafova horizontalno 100 mm i vertikalno 57,5 mm - dimenzije (V Š D): 188x68x45,5 mm 6 modules S45 and 7 modules S44 rectangular box - screws fixing centres horizontal 100 mm and vertical 57,5 mm - dimensions (L H D): 188x68x45,5 mm		22 22

Dodatna oprema za ugradne kutije - za gipskartonske zidove Accessories for flush mounted boxes - hollow walls



Sertifikati str. 417 Certificates page 417



253CGAV



25TTC20

25TTC25

25TTC32

Kod Code	Opis Description	Info	€
253CGAV	Izolaciona membrana za kutiju 253CG Insulating membrane for box 253CG		5 5
25TTC20	Čep za rebraste cevi Ø 20 mm ² Plug for corrugated duct Ø 20 mm ²		20 20
25TTC25	Čep za rebraste cevi Ø 25 mm ² Plug for corrugated duct Ø 25 mm ²		20 20
25TTC32	Čep za rebraste cevi Ø 32 mm ² Plug for corrugated duct Ø 32 mm ²		20 20
F-BOX	Paneli od vatrootpornog materijala na bazi grafita za zaštitu od vatre (REI 120) za kutiju 253CG - V x Š x D: 85x160x30 mm. Panel in intumescent material with base of graphite for fire protection REI 120 for 253CG box - L x H x D: 85x160x30 mm.		1 1
25SCG	Set razdelnika za kutije 253CG-254CG-256CG Clip-in divider for 253CG-254CG-256CG boxes		1 50
BLS05CG	Set razdelnika za multifunkcionalne kutije BLS05CG Clip-in divider for BLS05CG multifunction box		1 25

Način upotrebe 253CGAV

253CGAV Instructions

VAŽNO: UPOTREBA IZOLACIONE MEMBRANE OMOGUĆAVA ZNAČAJNO SMANJENJE GUBITKA VAZDUHA KROZ CEVI I KROZ ŠUPLJINE U ZIDU POBOLJŠAVAJUĆI TAKO ENERGETSKU EFIKASNOST OBJEKTA (NA RASPOLAGANJU JE TEST/IZVEŠTAJ TÜV)

NOTICE: the use of the membrane allows to considerably reduce air leaks in the piping and in the cavities of the walls thus improving the energy efficiency of the building (TUV test report available)

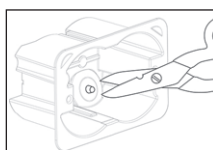

ISEĆI VRH
MEMBRANE

CUT THE PROPER "NIB"
OF THE MEMBRANE

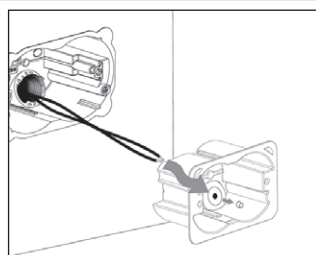

PROVUCITE KABLOVE KROZ OTVOR NA MEMBRANI
INSERT THE WIRES INTO THE HOLE OF THE MEMBRANE

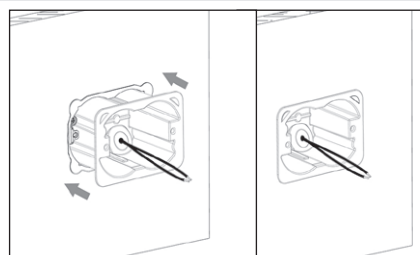

POSTAVITE MEMBRANU U KUTIJU
INSERT THE MEMBRANE INTO THE BOX

Završite instalaciju postavljanjem armature, izvršite kabliranje uređaja i postavite masku

Finish installing the frame, wire the devices and put on the front plate



Za raspoloživost kontaktirajte Ave distributere
For availability please contact sales dept.



Dostupni dok se ne rasprodaju zalihe
Available until stock out



Proizvod 2 modula pogodan za okruglu kutiju
2 modules product suitable for round box



Proizvod za pravougaone kutije britanskog standarda
Product for British standard rectangular box



Proizvod za izvoz
For Export only

Specijalne ugradne kutije za instalaciju u ravni sa zidom Special boxes for wall-lined installation

PATENTI AVE[®] 209
AVEPATENTS N^o 209

Kod Code	Opis Description	Info	€
SFM3CG	Ugradna kutija za 3 modula za gipskartonske zidove - rastojanje između šrafova 83,5 mm - isporučuje se sa šablonom za pravljenje otvora, libelom i sa bojivim okvirom (u ravni sa zidom) - u kompletu sa armaturom za 3 modula Sistema 44 <i>3 modules box for hollow walls - screw fixing centre 83,5 mm - supplied with template, spirit level and paintable frame (leant against the wall) and "System 44" 3 modules frame</i>	2	2
SFM3CG/HP	Ugradna kutija za 3 modula za gipskartonske - rastojanje između šrafova 83,5 mm - isporučuje se sa šablonom za pravljenje otvora, libelom i okvirom u kompletu sa armaturom za 3 modula Sistema 44 <i>3 modules box for hollow walls - screw fixing centre 83,5 mm - supplied with template, spirit level and System 44 3 modules frame</i>	1	1
CRFM3GSL	Rezervni unutrašnji okvir sjajne tamnosive boje (Life 44) - 3 modula <i>Spare inner frame - polished dark grey colour (Life 44) - 3 modules</i>	2	10

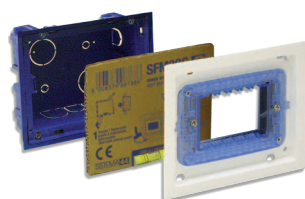

SFM3CG

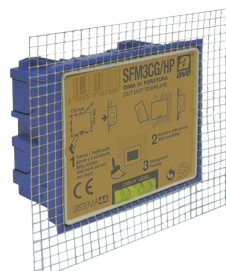

SFM3CG/HP

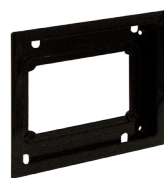

CRFM3GSL

Napomena: ugradna kutija + maska "Ave Touch" garanturu stepen zaštite IP44
Note: the box with the "Ave Touch" front plate guarantees an IP44 protection degree

Dimenzije Overall dimensions

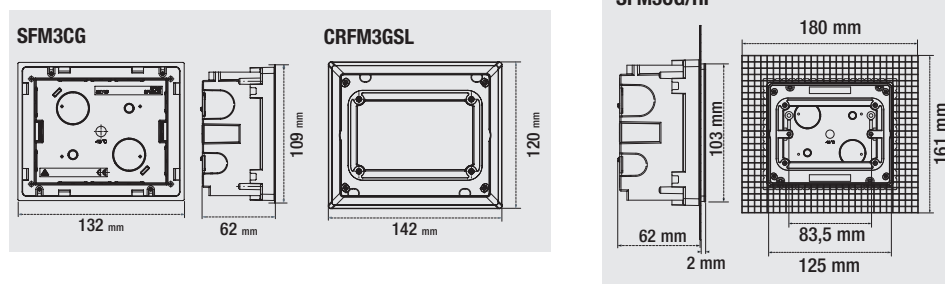

SFM3CG Ugradna kutija za gips/kartonske zidove SFM3CG BOX FOR HOLLOW WALLS

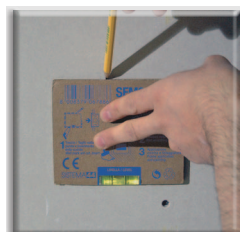

1 Postavite šablon za pravljenje otvora na zid i pomoću libele, označite liniju za prosecanje otvora
Use the level to fix the template then trace the line

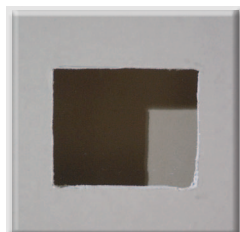

2 Napravite otvor
Make the hole



3 Postavite kutiju, pričvrstite je za zid, potom izravnajte zid (nemojte postavljati okvir)
After installing the box, smooth the wall (do not install the inner frame)

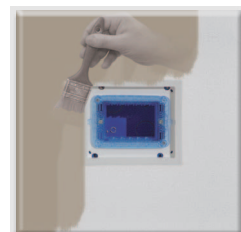

4 Pričvrstite okvir na kutiju, i nakon toga obojite zid zajedno sa okvirom
Install the inner frame, and after, paint the wall and the inner frame



5 Postavite masku
Place the finishing front plate

SFM3CG/HP Ugradna kutija za gips/kartonske zidove

SFM3CG/HP BOX FOR HOLLOW WALLS

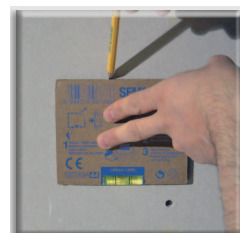

1 Postavite šablon za pravljenje otvora na zid i pomoću libele, označite liniju za prosecanje otvora
Use the level to fix the template then trace the line



2 Napravite otvor
Make the hole

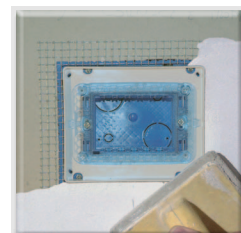

3 Postavite kutiju, pričvrstite je na zid, a potom izravnajte zid
After installing the box, smooth the wall

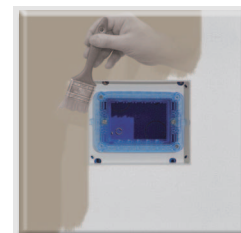

4 Obojite zid
Paint the wall

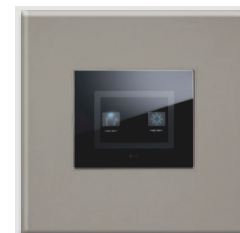

5 Postavite masku
Place the finishing front plate

◇ Proizvod za kvadratnu kutiju
Product for British Standard square box only

② Proizvod 1 modula koji se može postaviti u okruglu kutiju sa drugim proizvodom 1 modula
1 module product installable in round box with another 1 module device

□ Min. pakovanje kom.
Min. Packaging pcs

□ Stand. pakovanje kom.
Std. Packaging pcs



Ugradne kutije za elektrogalanteriju

Flush Mounted Boxes for Wiring Accessories

Ugradne kutije "maxi modul" za pune zidove - plava RAL 5017

Maxi module boxes for brickwork walls - RAL 5017 blue

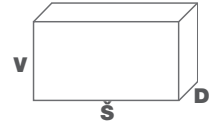

398



BL05P



BL07P

Kod Code	Opis Description	Info	€
BL02P	Multifunkcionalna ugradna kutija sa zaštitnim kartonom za 6 (3+3) modula S44 i S45 dimenzije (V Š D): 136x106x53 mm 6 modules (3+3) S44 and S45 multifunction box with mortar proof cover dimensions (L H D): 136x106x53 mm	70	70
BL05P	Multifunkcionalna ugradna kutija sa zaštitnim kartonom za 10 modula S45 i za 12 modula S44 dimenzije (V Š D): 168x137x73 mm 10 modules S45 and 12 modules S44 multifunction box with mortar proof cover dimensions (L H D): 168x137x73 mm	40	40
BL06P	Multifunkcionalna ugradna kutija sa zaštitnim kartonom za 15 modula S45 dimenzije (V Š D): 192x168x73 mm 15 modules S45 multifunction box with mortar proof cover dimensions (L H D): 192x168x73 mm	30	30
BL07P	Multifunkcionalna ugradna kutija sa zaštitnim kartonom za 20 modula S45 dimenzije (V Š D): 263x166x73 mm 20 modules S45 multifunction box with mortar proof cover dimensions (L H D): 263x166x73 mm	20	20

Napomena: ✓ armature koje se mogu koristiti iz Sistema 44 str. 170 i iz Sistema 45 str. 278

Note: ✓ coupleable frames System44 pag. 170 and System45 pag. 278

Ugradne kutije "maxi modul" za gipskartonske zidove - plava RAL 5017 Maxi module boxes for hollow walls - RAL 5017 blue

Kod Code	Opis Description	Info	€
BL02CG	Multifunkcionalna ugradna kutija za 6 (3+3) modula S44 i S45 - dimenzije (V Š D): 116x99x51 mm 6 (3+3) mod. S45 e S44 multifunction box - dimensions (L H D): 116x99x51 mm	18	18
BL05CG	Multifunkcionalna ugradna kutija za 10 modula S45 i 12 modula S44 - dimenzije (V Š D): 149x167x57 mm 10 modules S45 and 12 modules S44 multifunction box dimensions (L H D): 149x167x57 mm	7	7
BL06CG	Multifunkcionalna ugradna kutija za 15 modula S45 - dimenzije (V Š D): 202x165x72 mm Multifunction box 15 modules S45 dimensions (L H D): 202x165x72 mm	6	6
BL07CG	Multifunkcionalna ugradna kutija za 20 modula S45 - dimenzije (V Š D): 273x164x72 mm Multifunction box 20 modules S45 dimensions (L H D): 273x164x72 mm	5	5
BL07CGN	Multifunkcionalna ugradna kutija za 20 modula S45 - dimenzije (V Š D): 263x166x73 mm Multifunction box 20 mod. S45 - dimensions (L H D): 263x166x73 mm	20	20

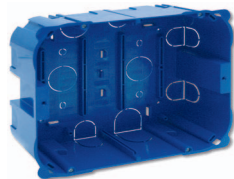

BL05CG

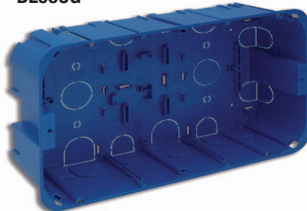

BL07CG

Napomena: ✓ armature koje se mogu koristiti iz Sistema 44 str. 170 i iz Sistema 45 str. 278

Note: ✓ coupleable frames System44 page 170 and System45 page 278

Ugradne kutije za zidove od sipreks bloka

Boxes for aerated concrete walls

Kod Code	Opis Description	Info	€
251GB	Okrugla kutija za 1-2 modula za S44 i S45 - dimenzije (Ø P): 67x46 mm 1-2 modules S44 and S45 round box - dimensions (Ø D): 67x46 mm	230	230
253GB	Pravougaona kutija za 3 modula za S44 i S45 - rastojanje između šrafova 83,5 mm dimenzije(L H P): 113x67x46 mm 3 modules S44 and S45 rectangular box - screws fixing centres 83,5 mm dimensions (L H D): 113x67x46 mm	180	180



251GB



253GB

Napomena: ✓ armature koje se mogu koristiti iz Sistema 44 str. 170 i iz Sistema 45 str. 278

Note: ✓ coupleable frames System44 page 170 and System45 page 278



Za raspoloživost kontaktirajte Ave distributere
For availability please contact sales dept.



Dostupni dok se ne rasprodaju zalihe
Available until stock out



Proizvod 2 modula pogodan za okruglu kutiju
2 modules product suitable for round box



Proizvod za pravougaone kutije britanskog standarda
Product for British standard rectangular box



Proizvod za izvoz
For Export only





Multifunkcionalne ugradne razvodne kutije

Flush Mounted Multifunction Boxes







Ugradne kutije za pune zidove - plava RAL 5017
Boxes for brickwork walls - RAL 5017 blue

PATENTI AVE N° 175 - 177 AVEPATENTS N° 175 - 177

	Kod Code	Opis Description	Info	€
	BL01P	Ugradna razvodna kutija sa zaštitnim kartonom - dimenzije (V Š D): 108x108x53 mm Junction box with mortar-proof cover - dimensions (L H D): 108x108x53 mm		125 125
	BL02P	Ugradna razvodna kutija sa zaštitnim kartonom - dimenzije (V Š D): 136x106x53 mm Multifunction box with mortar-proof cover - dimensions (L H D): 136x106x53 mm		70 70
	BL03P	Ugradna razvodna kutija sa zaštitnim kartonom - dimenzije (V Š D): 138x108x73 mm Multifunction box with mortar-proof cover - dimensions (L H D): 138x108x73 mm		70 70
	BL04P	Ugradna razvodna kutija sa zaštitnim kartonom - dimenzije (V Š D): 163x108x73 mm Junction box with mortar-proof cover - dimensions (L H D): 163x108x73 mm		65 65
	BL05P	Ugradna razvodna kutija sa zaštitnim kartonom - dimenzije (V Š D): 168x137x73 mm Multifunction box with mortar-proof cover - dimensions (L H D): 168x137x73 mm		40 40
	BL06P	Ugradna razvodna kutija sa zaštitnim kartonom - dimenzije (V Š D): 192x168x73 mm Multifunction box with mortar-proof cover - dimensions (L H D): 192x168x73 mm		30 30
	BL07P	Ugradna razvodna kutija sa zaštitnim kartonom - dimenzije (V Š D): 263x166x73 mm Multifunction box with mortar-proof cover - dimensions (L H D): 263x166x73 mm		20 20
	BL08LP	Ugradna razvodna kutija sa zaštitnim kartonom - dimenzije (V Š D): 398x168x73 mm Junction box with mortar-proof cover - dimensions (L H D): 398x168x73 mm		12 12
	BL08P	Ugradna razvodna kutija sa zaštitnim kartonom - dimenzije (V Š D): 317x263x73 mm Multifunction box with mortar-proof cover - dimensions (L H D): 317x263x73 mm		12 12
	BL09P	Ugradna razvodna kutija sa zaštitnim kartonom - dimenzije (V Š D): 498x169x73 mm Junction box with mortar-proof cover - dimensions (L H D): 498x169x73 mm		10 10
	BL10S	Ugradna razvodna kutija (bez zaštitnog kartona) - dimenzije (V Š D): 537x191x80 mm Junction box (mortar covers sold separately) - dimensions (L H D): 537x191x80 mm		10 10
	BL10PM	Zaštitni karton za razvodnu kutiju BL10S Cardboard mortar-proof cover for BL10S box		1 1
	BL18S	Ugradna razvodna kutija koja se koristi sa poklopcem 53T18xx (18 modula DIN) dimenzije (V Š D): 372x258x75 mm Box to be used with 53T18xx front cover (18 DIN mod.) dimensions (L H D): 372x258x75 mm		6 6
	BL18TS04	Ugradna razvodna kutija za ekran na dodir TS04 dimenzije (V Š D): 372x258x75 mm Box for TS04 touch screen dimensions (L H D): 372x258x75 mm		1 1
	53S02	Ugradna razvodna kutija koja se koristi sa poklopcem 53C02 (2 modula DIN) dimenzije (V Š D): 66x130x50 mm Box to be used with 53C02 front cover (2 DIN mod.) dimensions (L H D): 66x130x50 mm		1 40
	53S36	Ugradna razvodna kutija koja se koristi sa poklopcem 53T36xx (36 modula DIN) dimenzije (V Š D): 372x368x73 mm Box to be used with 53T36xx front cover (36 DIN modules) dimensions (L H D): 372x368x73 mm		4 4

Dodatna oprema za ugradne razvodne kutije - puni zidovi

Accessories for flush mounted junction boxes - brickwork walls

	Kod Code	Opis Description	Info	€
 	BLAS1	Oprema za spajanje razvodnih kutija: BL01P/BL05P/BL06P/BL07P/BL08P/BL08LP/ BL09P/BL10S/BL18S/53S36 Box coupler to be used with: BL01P/BL05P/BL06P/BL07P/BL08P/BL08LP/ BL09P/BL10S/BL18S/53S36		20 20
	BLAS2	Oprema za spajanje razvodnih kutija: 2503MG/SFM3/2504/2506/BL02P/BL03P/BL04P Box coupler for boxes: 2503MG/SFM3/2504/2506/BL02P/BL03P/BL04P		20 20
 	BLAS25	Oprema za spajanje razvodnih kutija: 2503MG/SFM3/2504/2506/BL02P/BL03P/BL04P Box coupler to be used with: 2503MG/SFM3/2504/2506/BL02P/BL03P/BL04P		20 20
	BLPF07	Metalna pločica za kutiju BL07P Metal plate for BL07P box		1 1
	BLS08	Razdelnik za razvodne kutije: BL05P/BL06P/BL07P/BL08P/BL08LP/BL09P/BL10S Clip-in divider for boxes: BL05P/BL06P/BL07P/BL08P/BL08LP/BL09P/BL10S		10 10
	BLV0960	Šraf za poklopac razvodne kutije serija BL - dužina = 25mm Screw for BL series lids - length = 25mm		200 200
	012DR	12-polna sabirnica za uzemljenje ili nulu za razvodne kutije počevši od BL05P 12 way earth/neutral terminal bar for junction boxes starting from BL05P		1 1

Kutije, kućišta i razvodne table
Boxes, Enclosure and Consumer Units

◇ Proizvod za kvadratnu kutiju
Product for British Standard square box only

② Proizvod 1 modula koji se može postaviti u okruglu kutiju sa drugim proizvodom 1 modula
1 module product installable in round box with another 1 module device

□ Mln. pakovanje kom.
Min. Packaging pcs

□ Stand. pakovanje kom.
Std. Packaging pcs







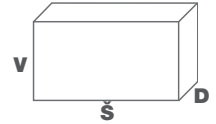

Multifunkcionalne ugradne razvodne kutije

Flush Mounted Multifunction Boxes

Poklopci sa stepenom zaštite IP40 za razvodne kutije za pune zidove - bela RAL 9016
Lids for IP40 junction boxes - brickwork walls - RAL 9016 white

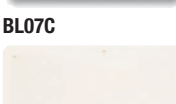

400



	Kod Code	Opis Description	Info	€
	BL01C	Poklopac otporan na udarce za kutiju BL01P - dimenzije (V Š D): 110x110x4 mm Shock proof lid for BL01P box - dimensions (L H D): 110x110x4 mm	1	125
	BL02C	Poklopac otporan na udarce za kutije BL02P i BL03P - dimenzije (V Š D): 140x110x4 mm Shock proof lid for BL02P and BL03P boxes - dimensions (L H D): 140x110x4 mm	1	70
	BL05C	Poklopac otporan na udarce za kutiju BL05P - dimenzije (V Š D): 184x153x4,5 mm Shock proof lid for BL05P box - dimensions (L H D): 184x153x4,5 mm	1	40
	BL06C	Poklopac otporan na udarce za kutiju BL06P - dimenzije (V Š D): 207x184x4,5 mm Shock proof lid for BL06P box - dimensions (L H D): 207x184x4,5 mm	1	30
	BL07C	Poklopac otporan na udarce za kutiju BL07P - dimenzije (V Š D): 279x184x4,5 mm Shock proof lid for BL07P box - dimensions (L H D): 279x184x4,5 mm	1	20
	BL08C	Poklopac otporan na udarce za kutiju BL08P - dimenzije (V Š D): 332,5x279x4,5 mm Shock proof lid for BL08P box - dimensions (L H D): 332,5x279x4,5 mm	1	24
	BL08LC	Poklopac otporan na udarce za kutiju BL08LP - dimenzije (V Š D): 414x184x4,5 mm Shock proof lid for BL08LP box - dimensions (L H D): 414x184x4,5 mm	1	84
	BL09C	Poklopac otporan na udarce za kutiju BL09P - dimenzije (V Š D): 514x184x4,5 mm Shock proof lid for BL09P box - dimensions (L H D): 514x184x4,5 mm	1	100
	BL10C	Poklopac otporan na udarce za kutiju BL10S - dimenzije (V Š D): 553x207x4,5 mm Shock proof lid for BL10S box - dimensions (L H D): 553x207x4,5 mm	1	70

Otpornost na udarce: IK 07
Shock resistance: IK 07

BL08C

BL08LC

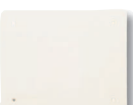
Poklopci sa stepenom zaštite IP55 za razvodne kutije za pune zidove - bela RAL 9016
Lids for IP55 junction boxes - brickwork walls - RAL 9016 white

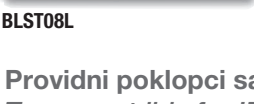

	Kod Code	Opis Description	Info	€
	BLST05	Vodootporni poklopac za kutiju BL05P - dimenzije (V Š D): 184x153x4,5 mm Splash proof lid for BL05P box - dimensions (L H D): 184x153x4,5 mm	1	40
	BLST06	Vodootporni poklopac za kutiju BL06P - dimenzije (V Š D): 207x184x4,5 mm Splash proof lid for BL06P box - dimensions (L H D): 207x184x4,5 mm	1	30
	BLST07	Vodootporni poklopac za kutiju BL07P - dimenzije (V Š D): 279x184x4,5 mm Splash proof lid for BL07P box - dimensions (L H D): 279x184x4,5 mm	1	20
	BLST08	Vodootporni poklopac za kutiju BL08P - dimenzije (V Š D): 332,5x279x4,5 mm Splash proof lid for BL08P box - dimensions (L H D): 332,5x279x4,5 mm	1	20
	BLST08L	Vodootporni poklopac za kutiju BL08LP - dimenzije (V Š D): 414x184x4,5 mm Splash proof lid for BL08LP box - dimensions (L H D): 414x184x4,5 mm	1	12

GWT (otpornost na vatru): 850°C - Otpornost na udarce: IK 10
GWT (flame resistance): 850°C - Shock resistance: IK 10

BLST06

BLST08L

Providni poklopci sa stepenom zaštite IP55 za razvodne kutije za pune zidove
Transparent lids for IP55 junction boxes - brickwork walls

	Kod Code	Opis Description	Info	€
	BLST05TR	Providni poklopac otporan na udarce za kutiju BL05P - dimenzije (V Š D): 184x153x4,5 mm Transparent shock proof lid for BL05P box - dimensions (L H D): 184x153x4,5 mm	1	40
	BLST06TR	Providni poklopac otporan na udarce za kutiju BL06P - dimenzije (V Š D): 207x184x4,5 mm Transparent shock proof lid for BL06P box - dimensions (L H D): 207x184x4,5 mm	1	30

GWT (otpornost na vatru): 850°C - Otpornost na udarce: IK 10
GWT (flame resistance): 850°C - Shock resistance: IK 10

BLST05TR

BLST06TR



Za raspoloživost kontaktirajte
Ave distributere
For availability please contact
sales dept.



Dostupni dok se ne
rasprodaju zalihe
Available until stock out



Proizvod 2 modula pogodan
za okruglu kutiju
2 modules product suitable
for round box



Proizvod za pravougaone
kutije britanskog standarda
Product for British standard
rectangular box



Proizvod za
izvoz
For Export
only

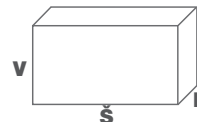





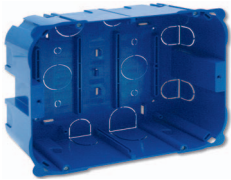
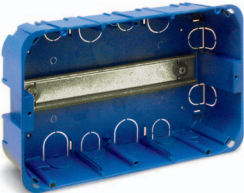



Ugradne kutije za gipskartonske zidove - plava RAL 5017 Boxes for hollow walls - application by milling - RAL 5017 blue

PATENTI AVE N° 175 - 177 AVE PATENTS N° 175 - 177



	Kod Code	Opis Description	Info	€	401
	BL05CG	Multifunkcionalna ugradna kutija dimenzija (V Š D): 144x162x59 mm Multifunction box dimensions (L H D): 144x162x59 mm		7 7	
	BL06CG	Multifunkcionalna ugradna kutija dimenzija (V Š D): 198x161x75 mm Multifunction box dimensions (L H D): 198x161x75 mm		6 6	
	BL07CG	Multifunkcionalna ugradna kutija dimenzija (V Š D): 263x166x73 mm Multifunction box dimensions (L H D): 263x166x73 mm		5 5	
	BL07CGDOM	Ugradna kutija u kompletu sa DIN šinom za postavljanje uređaja kućne automatike dimenzija (V Š D): 263x166x73 mm Box with DIN module bar for home automation devices dimensions (L H D): 263x166x73 mm		5 5	
	BL08CG	Multifunkcionalna ugradna kutija dimenzija (V Š D): 263x317x73 mm Multifunction box dimensions (L H D): 263x317x73 mm		12 12	
	BL18CG	Ugradna kutija koja se koristi sa poklopcem 53T18xx (18 modula DIN) dimenzija (V Š D): 372x258x75 mm Box to be used with 53T18xx front cover (18 DIN mod.) dimensions (L H D): 372x258x75 mm		6 6	
	BL18CGTS04	Ugradna kutija za ekran na dodir TS04 dimenzija (V Š D): 372x258x75 mm Box for TS04 touch screen dimensions (L H D): 372x258x75 mm		1 1	
	GWT (otpornost na vatru): 850°C GWT (flame resistance): 850°C				
	Napomena: U kutiju BL07CGDOM moguće je instalirati DIN uređaje maksimalne dubine 64,5 mm				
	Note: In the box BL07CGDOM you can install DIN devices with maximum depth 64,5 mm				

Dodatna oprema za ugradne kutije za gipskartonske zidove Accessories for flush mounted boxes - hollow walls

	Kod Code	Opis Description	Info	€
	25TTC20	Čep za rebraste cevi Ø 20 mm ² Plug for corrugated duct Ø 20 mm ²		1 20
	25TTC25	Čep za rebraste cevi Ø 25 mm ² Plug for corrugated duct Ø 25 mm ²		1 20
	25TTC32	Čep za rebraste cevi Ø 32 mm ² Plug for corrugated duct Ø 32 mm ²		1 20
	BLTCG	Pribor za fiksiranje rebrastih cevi na zid Kit for corrugated duct fixing on walls		1 10
	BLS05CG	Set razdelnika za multifunkcionalne ugradne kutije BL05CG Clip-in divider for BL05CG multifunction box		1 25
	LIVELAVE	Mini ličela za ugradne kutije BL06P-BL07CG-BL18S-BL18CG-BL18TS04-BL18CGTS04-SFM3 SFM3/HP-SFM3CG-SFM3CG/HP Spirit level for boxes BL06P-BL07CG-BL18S-BL18CG BL18TS04-BL18CGTS04-SFM3-SFM/HP-SFM3CG-SFM3CG/HP		5 5

 **Sertifikati na str. 417**
Certificates page 417

Poklopci sa stepenom zaštite IP40 za razvodne kutije za gipskartonske zidove - bela RAL 9016 Lids for IP40 junction boxes - hollow walls - RAL 9016 white

	Kod Code	Opis Description	Info	€
	BLCG05C	Antivandal poklopac za zaštitu od udaraca za kutije BL05CG i BL05P - dimenzije (V Š D): 184x153x4,5 mm Shock proof lid to be used with BL05CG and BL05P boxes dimensions (L H D): 184x153x4,5 mm		1 40
	BLCG06C	Antivandal poklopac za zaštitu od udaraca za kutije BL06CG i BL06P - dimenzije (V Š D): 207x184x4,5 mm Shock proof lid to be used with BL06CG and BL06P boxes dimensions (L H D): 207x184x4,5 mm		1 30
	BLCG07C	Antivandal poklopac za zaštitu od udaraca za kutije BL07CG, BL07P i BL07CGN - dimenzije (V Š D): 279x184x4,5 mm Shock proof lid to be used with BL07CG and BL07P boxes dimensions (L H D): 279x184x4,5 mm		1 20
	BLCG08C	Antivandal poklopac za zaštitu od udaraca za kutije BL08CG, BL08P i BL08CGN - dimenzije (V Š D): 332,5x279x4,5 mm Shock proof lid to be used with BL08CG and BL08P boxes dimensions (L H D): 332,5x279x4,5 mm		1 24
	GWT (otpornost na vatru): 850°C - Otpornost na udarce: IK 10			
	GWT (flame resistance): 850°C - Shock resistance: IK 10			

 Proizvod za kvadratnu kutiju
Product for British Standard square box only

 Proizvod 1 modula koji se može postaviti u okruglu kutiju sa drugim proizvodom 1 modula
1 module product installable in round box with another 1 module device

 Mln. pakovanje kom.
Min. Packaging pcs

 Stand. pakovanje kom.
Std. Packaging pcs

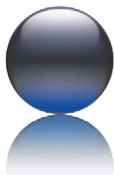

Multifunkcionalne ugradne razvodne kutije

Flush Mounted Multifunction Boxes

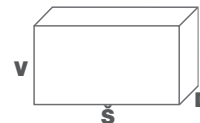

Ugradne kutije za gipskartonske zidove – “Dupla primena” - plava RAL 5017

Boxes for hollow walls – “Double Application” - RAL 5017 blue

PATENTIAVE N° 175 - 177 - 232 AVEPATENTS N° 175 - 177 - 232

402



BL07CGN

Kod Code	Opis Description	Info	€
BL02CG	Multifunkcionalna ugradna kutija dimenzija (V Š D): 136x106x53mm Multifunction box dimensions (L H D): 136x106x53 mm	18	18
BL07CGN	Multifunkcionalna ugradna kutija dimenzija (V Š D): 263x166x73 mm Multifunction box dimensions (L H D): 263x166x73 mm	20	20
BL08CGN	Multifunkcionalna ugradna kutija dimenzija (V Š D): 317x263x73 mm Multifunction box dimensions (L H D): 317x263x73 mm	12	12
BL08LCGC	Multifunkcionalna ugradna kutija sa poklopcem IP40 dimenzija (V Š D): 398x168x73 mm Junction box with lid - IP40 - dimensions (L H D): 398x168x73 mm	12	12
BL09CGC	Multifunkcionalna ugradna kutija sa poklopcem IP40 dimenzija: 498x169x73 mm Junction box with lid - IP40 - dimensions (L H D): 498x169x73 mm	10	10
53S36CG	Multifunkcionalna ugradna kutija sa poklopcem 53T36xx dimenzija (V Š D): 372x368x73 mm Box to be used with 53T36xx front lid - dimensions (L H D): 372x368x73 mm	4	4

GWT (otpornost na vatru): 850°C GWT (flame resistance): 850°C

ASORTIMAN AVE UGRADNIH KUTIJA ZA GIPSKARTONSKE ZIDOVE OBOGAĆEN JE NOVIM MODELIMA! TRI NOVA MODELA MULTIFUNKCIONALNIH KUTIJA, TRI MODELA RAZVODNIH KUTIJA I JEDAN ZA KONTROLNE JEDINICE. AVE IMA NAJKOMPLETNIJI ASORTIMAN UGRADNIH KUTIJA I PREDSTAVLJA GLAVNI IZBOR VODEĆIH PROIZVOĐAČA GIPSKARTONSKIH ZIDOVA KAO ŠTO SU KNAUF I SINIAT

THE RANGE OF BOXES FOR AVE HOLLOW WALLS IS ENRICHED WITH NEW VERSIONS !
THREE MULTI-FUNCTION VERSIONS , THREE VERSIONS OF JUNCTION BOXES ,AND A VERSION FOR CONSUMER UNIT
AVE HAS THE MOST COMPLETE RANGE OF BOXES AND IT HAS BEEN CHOSEN BY THE LEADING MANUFACTURERS OF HOLLOW WALLS SUCH AS KNAUF AND SINIAT



BL02CG



BL07CGN



BL08CGN

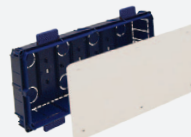

BL08LCGC

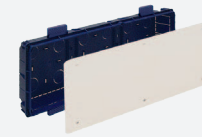

BL09CGC

Dodatna oprema za ugradne kutije za gipskartonske zidove Accessories for flush mounted boxes - hollow walls

Kod Code	Opis Description	Info	€
25TTC20	Čep za rebraste cevi Ø 20 mm ² Plug for corrugated duct Ø 20 mm ²		20 20
25TTC25	Čep za rebraste cevi Ø 25 mm ² Plug for corrugated duct Ø 25 mm ²		20 20
25TTC32	Čep za rebraste cevi Ø 32 mm ² Plug for corrugated duct Ø 32 mm ²		20 20
BLTCG	Pribor za fiksiranje rebrastih cevi na zid Kit for corrugated duct fixing on walls		1 10
BLS08CG	Set razdelnika za multifunkcionalne ugradne kutije BL07CGN, BL08CGN, BL08LCGC, BL09CGC Clip-in divider for BL07CGN, BL08CGN, BL08LCGC, BL09CGC boxes		10 10
LIVELAVE	Mini ličebela za ugradne kutije BL06P, BL07CG, BL07CGN, BL18S, BL18CG, BL18TS04, BL18CGTS04, SFM3, SFM3/HP, SFM3CG, SFM3CG/HP Spirit level for boxes BL06P, BL07CG, BL07CGN, BL18S, BL18CG, BL18TS04, BL18CGTS04, SFM3, SFM/HP, SFM3CG, SFM3CG/HP		5 5

BLTCG



Sertifikati str. 417 Certificates page 417

Poklopci sa stepenom zaštite IP40 za razvodne kutije za gipskartonske zidove - bela RAL 9016

Lids for IP40 junction boxes - hollow walls - RAL 9016 white

Kod Code	Opis Description	Info	€
BLCG02C	Poklopac otporan na udarce za kutije BL02CG - dimenzije (V Š D): 140x110x4 mm Shock proof lid to be used with BL02CG boxes - dimensions (L H D): 140x110x4 mm		1 70
BLCG07C	Poklopac otporan na udarce za kutije BL07CG, BL07CGN i BL07P dimenzije (V Š D): 279x184x4,5 mm Shock proof lid to be used with BL07CG, BL07CGN and BL07P boxes dimensions (L H D): 279x184x4,5 mm		1 20
BLCG08C	Poklopac otporan na udarce za kutije BL08CG, BL08CGN i BL08P dimenzije (V Š D): 332,5x279x4,5 mm Shock proof lid to be used with BL08CG, BL08CGN and BL08P boxes dimensions (L H D): 332,5x279x4,5 mm		1 24

BLCG05C

BLCG07C

GWT (otpornost na vatru): 850°C - Otpornost na udarce: IK 10
GWT (flame resistance): 850°C - Shock resistance: IK 10



Za raspoloživost kontaktirajte Ave distributere
For availability please contact sales dept.



Dostupni dok se ne rasprodaju zalihe
Available until stock out



Proizvod 2 modula pogodan za okruglu kutiju
2 modules product suitable for round box



Proizvod za pravougaone kutije britanskog standarda
Product for British standard rectangular box



Proizvod za izvoz
For Export only

Tehničke karakteristike Technical Features

PATENTI AVE N° 175 - 177 - 232 AVEPATENTS N° 175 - 177 - 232

403

UŠICE ZA FIKSIRANJE

IZRAĐENE SU U SAČASTOJ STRUKTURI KAKO BI SE OLAKŠALO POSTAVLJANJE ŠRAFOVA PRILIKOM FIKSIRANJA KUTIJE NA ZID

FIXING TABS WITH CELL STRUCTURE

PRODUCED WITH CELL STRUCTURE TO FACILITATE ENTRY OF THE SCREW WHEN FIXING THE BOX TO THE WALL

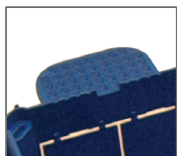

OTVORI NA DNU KUTIJE

OLAKŠAVAJU POSTAVLJANJE KABLOVA ILI REBRASITIH CEVI POMOĆU VEZICA

SLOTS IN BOX BOTTOM

TO FACILITATE FIXING OF CABLES OR CORRUGATED TUBES USING STRAPS

ODLIČNA ČVRSTINA

POSTIŽE SE ZAHVALJUJUĆI OJAČANJIMA DUŽ IVICA I NA DNU KUTIJE

HIGH STRENGTH

THANKS TO THE RIBS ALONG THE EDGES AND ON THE BOTTOM OF THE BOX

PRIPREMLJENI OTVORI

OTVARANJEM PROREZA VEOMA SE POJEDNOSTAVLJUJE I UBRZAVA OPERACIJA PRAVLJENJA OTVORA

KNOCKOUT HOLES

BY INSERTING A COUNTERSINK IT IS MUCH SIMPLER AND FASTER TO REMOVE A SECTION

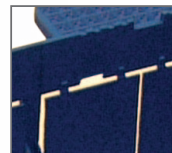

OZNAKA POZICIJE

POKAZUJE TAČNU POZICIJU UŠICA ZA POSTAVLJANJE ŠRAFOVA

POSITION MARK

INDICATES THE EXACT POSITION OF THE TABS FOR THE INSERTION OF THE SCREWS

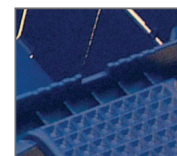

Primer instalacije Installation sequence

POSTAVLJANJE UNUTAR PANELE FIXING INSIDE THE PANEL

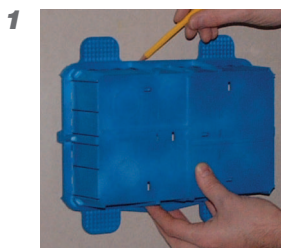

POSTAVITE UGRANU KUTIJU TAKO DA MOŽETE ISCRTATI ŠABLON ZA PRAVLJENJE OTVORA

USE THE BOX TO DRAW A TEMPLATE FOR THE HOLE



POSTAVLJANJE KUTIJE SA PREDNJE STRANE PANELE

INSERTING THE BOX FROM THE PANEL FRONT

POSTAVLJANJE NA PANELE FIXING IN FRONT OF THE PANEL

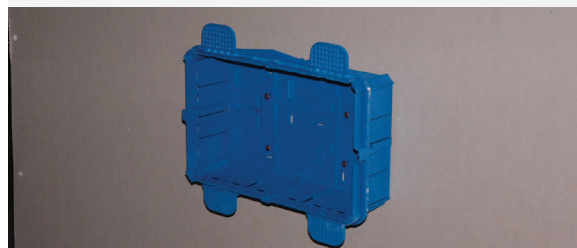

POSTAVITE KUTIJU DIREKTNO NA PREDNJU STRANU UNUTRAŠNJEG PANELE POMOĆU ŠRAFOVA

FIX THE BOX DIRECTLY IN THE FRONT OF THE INTERNAL PANEL USING SCREWS

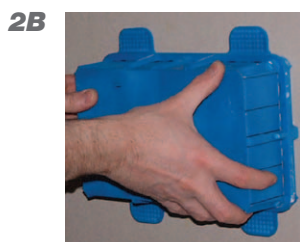

POSTAVLJANJE KUTIJE SA ZADNJE STRANE PANELE

ANCHORING THE BOX FROM THE BACK OF THE PANEL



POSTAVLJANJE ŠRAFOVA U UŠICE ZA FIKSIRANJE SA PREDNJE STRANE PANELE

SCREWS INSERTION IN THE FRONT OF THE PANEL USING THE FIXING TABS

IL NUOVO SISTEMA DI FISSAGGIO PERMETTE L'APPLICAZIONE ALLA LASTRA DA ENTRAMBI I LATI DIMEZZANDO COSÌ I TEMPI DI INSTALLAZIONE!!

THE NEW FIXING SYSTEM MAKES IT POSSIBLE TO FIT THE BOX TO THE PANEL FROM BOTH SIDES THUS HALVING THE TIME NEEDED FOR INSTALLATION!!

◇ Proizvod za kvadratnu kutiju
Product for British Standard square box only

② Proizvod 1 modula koji se može postaviti u okruglu kutiju sa drugim proizvodom 1 modula
1 module product installable in round box with another 1 module device

☐ Min. pakovanje kom.
Min. Packaging pcs

☐ Stand. pakovanje kom.
Std. Packaging pcs

Ugradne razvodne table od 2 do 36 modula

Flush Mounted Consumer Units 2 to 36 modules



IP40
IP40

Dizajn M. Hasuike

405

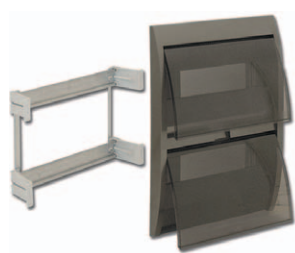

53T36G

Kod Code	Opis Description	Info	€
53T36BG	Kao iznad, poklopac bele boje Banquise RAL 9016 <i>Same as above, RAL 9016 Banquise white cover</i>	* 49W	1 6
53T36BP	Kao iznad, poklopac bele boje Blanc RAL 1013 <i>Same as above, RAL 1013 Blanc white cover</i>		1 6
53T36G	Kao iznad, poklopac metalik sive boje <i>Same as above, Metallic grey cover</i>		1 6
53T36NAL	Kao iznad, poklopac crne boje Life <i>Same as above, Life black cover</i>		1 6
53T36B	Kao iznad, poklopac bele boje Domus RAL 9010 <i>Same as above, RAL 9010 Domus white cover</i>		1 6
53T36R	Kao iznad, poklopac sive boje RAL 7035 <i>Same as above, RAL 7035 cover</i>		1 6

* **Napomena:** Navedena kutija je obavezna u slučaju postavljanja poklopca na šuplje zidove i pregrade u skladu sa propisom CEI 23-48 / IEC 60670 i u skladu sa testom Glow Wire Test 850°C

* **Note:** The indicated box is required to install the cover on hollow and partition walls in compliance with CEI 23-48 / IEC 60670 and a Glow Wire Test 850°C

*Pde = maksimalna dozvoljena disipacija *Pde = maximum capability to dissipate power

Tehničke karakteristike Technical features

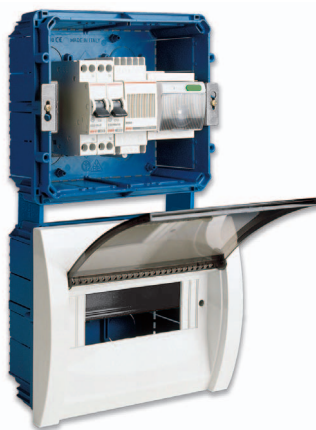

Kako bi se olakšalo kabliranje i instalacija, razvodne table od 24 i 36 modula poseduju jednodelni okvir koji se može skidati.
To make wiring and installation easier, the 24 and 36 module enclosures are provided with a single removable frame



Otvori za prostiranje zvučnih signala
Holes for acoustics signal sound propagation

IP40 IP40



53Q20N

Kod Code	Opis Description	Info	€
53Q20N	Poklopac sive boje RAL 7035 u kompletu sa DIN šinom - lomljivo staklo - 4 modula DIN koristi se sa kutijom BLO3P - dimenzije (V Š D): 109x136x38 mm <i>RAL 7035 cover provided with DIN bar - breakable glass - 4 DIN mod. to be used with BLO3P boxes - dimensions (L H D): 109x136x38 mm</i>		1 2
Q021	Metalna bravica sa ključem za ugradne kutije 53Q20N <i>Metal lock with key for 53Q20N</i>		1 1

IP55 IP55

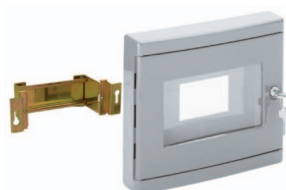

53ST08E

Kod Code	Opis Description	Info	€
53ST08E	Poklopac sive boje RAL 7035 u kompletu sa DIN šinom - 8 modula DIN - lomljivo staklo - sa metalnim ključem - koristi se sa kutijom BLO6P - dimenzije (V Š D): 217x185x40 mm <i>RAL 7035 cover for BLO6P box - provided with DIN bar - 8 DIN mod. with metallic key - breakable glass - dimensions (L H D): 217x185x40 mm</i>	* 12W	1 20

*Pde = maksimalna dozvoljena disipacija *Pde = maximum capability to dissipate power

◇ Proizvod za kvadratnu kutiju
Product for British Standard square box only

② Proizvod 1 modula koji se može postaviti u okruglu kutiju sa drugim proizvodom 1 modula
1 module product installable in round box with another 1 module device

☐ Mln. pakovanje kom.
Min. Packaging pcs

☐ Stand. pakovanje kom.
Std. Packaging pcs



Podne kutije

Outlet Socket Boxes

IP40
IP40

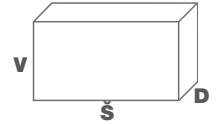

406

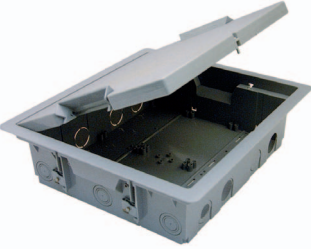
	Kod Code	Opis Description	Info	€
	44/45TFP1	Podna kutija 339x222x102mm - za 12 modula sistema 44 - za 8 modula sistema 45 4 modula DIN. <i>Outlet socket box 339x222x102mm - 12 mod. System 44 - 8 mod. System 45 - 2 DIN mod.</i>	1	1
	44/45TFP1X	Podna kutija sa INOX poklopcem 339x222x102mm za 12 modula sistema 44 - za 8 modula sistema 45 - 4 modula DIN. <i>Outlet socket box with stainless steel cover 339x222x102mm 12 mod. System 44 - 8 mod. System 45 - 2 DIN mod.</i>	1	1
	44/45TFP2	Podna kutija 339x374x102mm - za 24 modula sistema 44 - za 16 modula sistema 45 - 8 modula DIN <i>Outlet socket box 339x374x102mm - 24 mod. System 44 - 16 mod. System 45 - 4 DIN mod.</i>	1	1
	44/45TFP2X	Podna kutija sa INOX poklopcem 339x374x102mm 24 modula sistema 44 - 16 modula sistema 45 - 8 modula DIN. <i>Outlet socket box with stainless steel cover 339x374x102mm 24 mod. System 44 - 16 mod. System 45 - 4 DIN mod.</i>	1	1
44/45TFP2	BTFP1	Kutija od pocinkovanog čelika za 44/45TFP1 236x310x103mm u kompletu sa 2 adaptera (Ø 20 ili 25mm) <i>Galvanized sheet box for 44/45TFP1 236x310x103mm complete with 2 adapters (Ø 20 or 25mm)</i>	1	1
	BTFP2	Kutija od pocinkovanog čelika za 44/45TFP2 388x310x103mm kompletu sa 4 adaptera (Ø 20 ili 25mm) <i>Galvanized sheet box for 44/45TFP2 388x310x103mm complete with 4 adapters (Ø 20 or 25mm)</i>	1	1

Dodatna oprema Accessories

	Kod Code	Opis Description	Info	€
	44MAP6	Samonoseći adapter za 6 modula Sistema 44 (postavljanje i skidanje modula sa prednje strane) <i>Self-supporting front cover 6 mod. System 44 (frontal devices clipping and unclipping)</i>	1	1
	445MAR34	Samonoseći adapter za postavljanje armature za 3 ili 4 modula Sistema 45 <i>Front cover for frame clipping 3 or 4 modules System 45</i>	1	1
	DIN2M	Samonoseći adapter za 2 modula DIN <i>Front cover 2 DIN mod.</i>	1	1

44MAP6



445MAR34



DIN2M

Primer upotrebe Application example

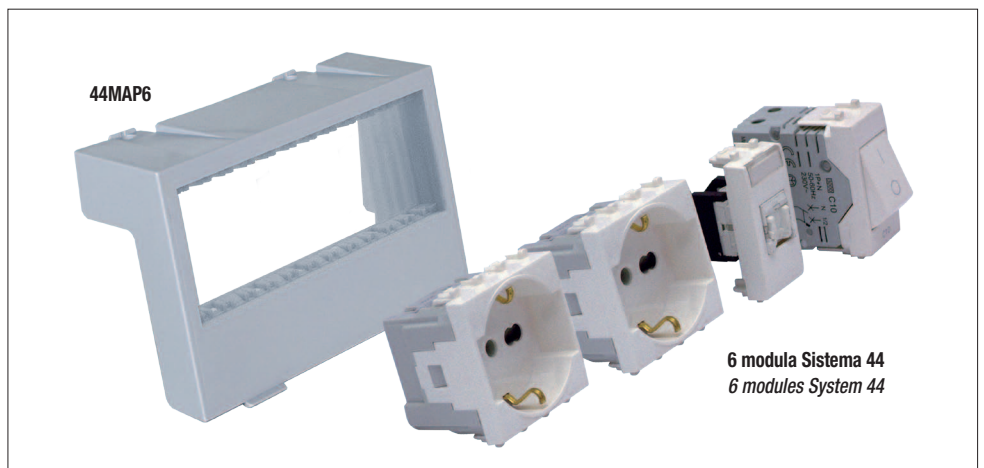

Za raspoloživost kontaktirajte
Ave distributere
For availability please contact
sales dept.



Dostupni dok se ne
rasprodaju zalihe
Available until stock out



Proizvod 2 modula pogodan
za okruglu kutiju
2 modules product suitable
for round box



Proizvod za pravougaone
kutije britanskog standarda
Product for British standard
rectangular box



Proizvod za izvoz
For Export
only

1 Poklopac, 3 Rešenja

- Ravna strana, standardna primena.
- Pripremljena strana, postavljanje parketa i/ili podne obloge
- Ojačana strana, sa umetkom od nerđajućeg čelika INOX

1 Cover, 3 Solutions

- Smooth side, standard application
- Finished side, parquet and/or tiles application
- Reinforced, supplied with a stainless steel finishing

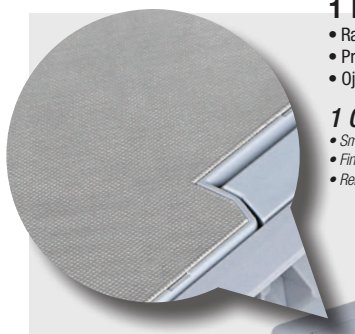
Sigurnosna brava

Pomoću specijalnog šrafa, sa metričkim navojem, vrši se fiksiranje na mesinganu biksnu kako bi se izbegla nepravilna upotreba.

Security Lock

Fixing to a brass bush to avoid any tampering through a special screw having a metric thread

Obezbeđen izlaz za kablove

Izlaz za kablove izrađen je od čvrste plastike garantujući tako sigurnu zaštitu kablova

Safe cable outlet

The cable outlet is made of rigid plastic assuring a safe cable protection

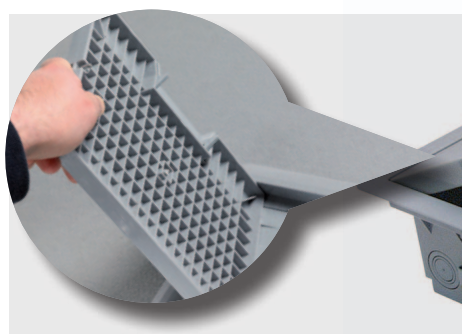
Skidanje poklopca

Poklopac se može vrlo lako skinuti sa kutije, bez lomljenja i/ili ogrebotina olakšavajući tako postupak instalacije.

Cover removal

The cover can be easily removed from the box to avoid cracks and/or scratches and to make it easier to install

Olakšana primena

Moguća je instalacija u podove sa podnim oblogama debljine od 20 do 60 mm, pomoću sistema za nivelisanje graničnika

Easy installation

It is possible the installation on floors with tiles having a thickness from 20 to 60 mm, and, through the system of re-positioned feet by a rubber, the application is easier

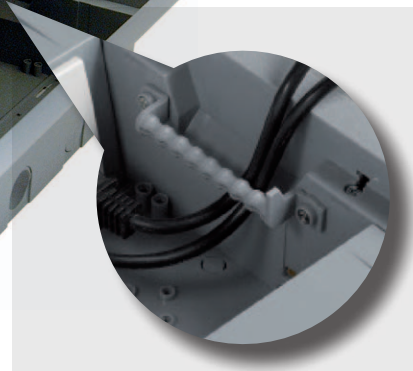
Blokiranje kablova

Sistem za blokiranje koji sprečava eventualno izvlačenje kablova, koji takođe omogućava grupisanje kablova radi bolje preglednosti

Cable block

Block system to avoid any tearing cable and to allow also a tidy grouping

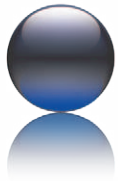

Kućišta za mini-kanalice

Enclosures for Mini Trunkings

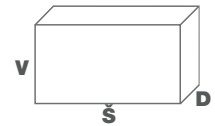

Nadgradno kućište IP40 za kanalice RAL 9010 bele boje - Sistem 44
RAL 9010 self-supporting enclosures IP40 - System44

408



44QC01



44QC02



44QC03

Kod Code	Opis Description	Info	€
44QC01	Nadgradno kućište IP40 za 1 modul S44 - za kanalice dimenzija od 20x10 mm do 30x18 mm - montaža baze i poklopca pomoću 2 šrafova <i>1 module - for mini trunkings from 20x10 mm to 30x18 mm fixing of base/cover with 2 screws</i>	24	24
44QC02	Nadgradno kućište IP40 za 2 modula S44 - za kanalice dimenzija od 20x10 mm do 30x18 mm - montaža baze i poklopca pomoću 2 šrafova <i>2 modules - for mini trunkings from 20x10 mm to 30x18 mm fixing of base/cover with 2 screws</i>	24	24
44QC03	Nadgradno kućište IP40 za 3 modula S44 - za kanalice dimenzija od 20x10 mm do 30x18 mm - montaža baze i poklopca pomoću 2 šrafova <i>3 modules - for mini trunkings from 20x10 mm to 30x18 mm fixing of base/cover with 2 screws</i>	20	20

Nota: postavljanje i skidanje uređaja vrši se sa zadnje strane poklopca
Note: devices coupling and removal from the rear part

Primer instalacije Installation example



Skidanje uređaja Devices removal

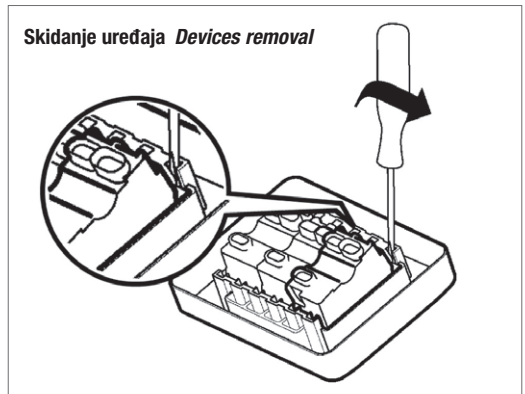

Samonoseća nadgradna kućišta IP40 RAL9016 "Yesmin" - Sistema45 "Yesmin" IP40 Enclosures - self-supporting - RAL 9016 - System45

Kod Code	Opis Description	Info	€
45QY01BB	1 modul - za kanalice od 20x10 mm do 30x18 mm fiksiranje baze/poklopac sa 2 šrafova - smanjena dubina <i>1 module - for mini trunkings from 20x10 mm to 30x18 mm fixing of base/cover with 2 screws - reduced depth</i>	1	30
45QY02BB	2 modula - za kanalice od 20x10 mm do 30x18 mm fiksiranje baze/poklopac sa 2 šrafova - smanjena dubina <i>2 modules - for mini trunkings from 20x10 mm to 30x18 mm fixing of base/cover with 2 screws - reduced depth</i>	1	30
45QY1BB	1 modul - za kanalice od 20x10 mm do 30x18 mm fiksiranje baze/poklopac sa 2 šrafova <i>1 module - for mini trunkings from 20x10 mm to 30x18 mm fixing of base/cover with 2 screws</i>	1	30
45QY2BB	2 modula - za kanalice od 20x10 mm do 30x18 mm fiksiranje baze/poklopac sa 2 šrafova <i>2 modules - for mini trunkings from 20x10 mm to 30x18 mm fixing of base/cover with 2 screws</i>	1	30



45QY01BB



45QY02BB



45QY1BB



45QY2BB



Za raspoloživost kontaktirajte Ave distributere
For availability please contact sales dept.



Dostupni dok se ne rasprodaju zalihe
Available until stock out



Proizvod 2 modula pogodan i za okrugle kutije
2 modules product suitable for round box



Proizvod za pravougaone kutije britanskog standarda
Product for British standard rectangular box



Proizvod za izvoz
For Export only

Kućišta za mini-kanalice

Enclosures for Mini Trunkings



Univerzalne kutije IP40 za kanalice RAL 9010 bele boje - Sistem 44 i Sistem 45
RAL 9010 Universal boxes IP40 for - System44 and System45

Kod Code	Opis Description	Info	€
44SC03	Univerzalna nadgradna kutija IP40 za 3 modula - koristi se sa standardnom armaturom za 3 modula (rastojanje između šrafova 83,5 mm) - za kanalice dimezija od 20x10 mm do 30x18 mm <i>3 modules - to be used with standard 3 module frames (centre distance 83,5 mm) for trunking from 20x10 mm to 30x18 mm</i>	1	20
44SC04	Univerzalna nadgradna kutija IP40 za 4 modula - koristi se sa standardnom armaturom za 4 modula (rastojanje između šrafova 108 mm) - za kanalice od 20x10 mm do 30x18 mm <i>4 modules - to be used with standard 4 module frames (centre distance 108 mm) for trunking from 20x10 mm to 30x18 mm</i>	1	15

44SC03

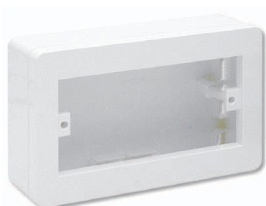

44SC04

Napomena: pogodne su i za maske iz Sistema 45
Note: suitable also for System 45 front plates

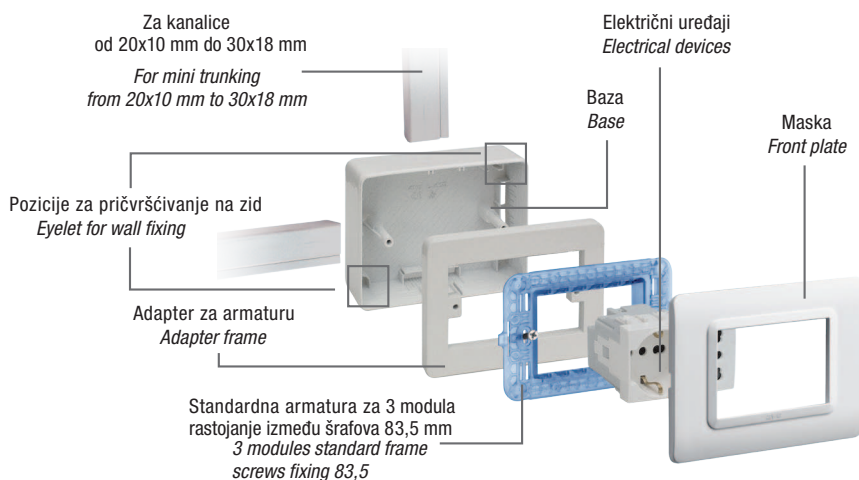

Primer instalacije
Installation example

Dodatna oprema Accessory

Kod Code	Opis Description	Info	€
45MM03	Prikjučak za uzemljenje Earth terminal	500	500



45MM03

Dimenzije (u mm)	Dimensions (mm)	Izgled sa zadnje strane Rear View
<p>44SC03</p> <p>123</p>	<p>46.5</p> <p>92</p>	<p>44SC03</p>
<p>44SC04</p> <p>146.5</p>	<p>46.5</p> <p>92</p>	<p>44SC04</p>

Kutije, kućišta i razvodne table
Boxes, Enclosures and Consumer Units

◇ Proizvod za kvadratnu kutiju
Product for British Standard square box only

② Proizvod 1 modula koji se može postaviti u okruglu kutiju sa drugim proizvodom 1 modula
1 module product installable in round box with another 1 module device

☐ Min. pakovanje kom.
Min. Packaging pcs

☑ Stand. pakovanje kom.
Std. Packaging pcs

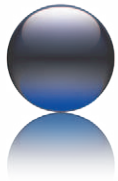

Kućišta za kanalice i mini-kanalice

Enclosures for Trunkings and Mini Trunkings

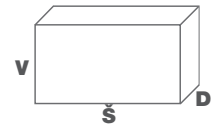

Nadgradne kutije RAL 9016 za maske "YES 45" - Sistem 45
Wall mounted boxes for "YES 45" front plates RAL 9016 - System45

410



45SY02



45SY2



45SY3

Kod Code	Opis Description	Info	€
45SY02	1-2 modula - smanjena dubina - koristi se sa armaturom 45362EX 1-2 modules - reduced depth box - to be used with 45362EX	1	30
45SY2	1-2 modula - koristi se sa armaturom 45362EX 1-2 modules - to be used with 45362EX	1	30
45SY3	3 modula - koristi se sa armaturom za 3 modula 45B63 u kompletu sa maskama 45PY01..., 45PY002..., 45PY02..., 45PY03... 3 modules Banquise white box to be used with 45B63 frames and 45PY01..., 45PY02..., 45PY002..., 45PY03.. front plates	1	24

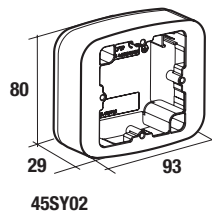

45SY02

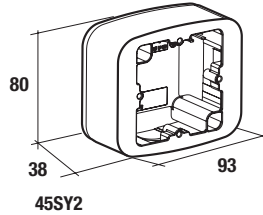

45SY2

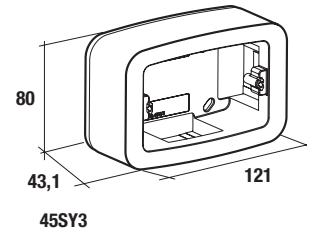

45SY3

Nadgradne kutije za maske "MAXI YES"

Wall mounted boxes for "MAXI YES" front plates

Kod Code	Opis Description	Info	€
45SY6	6 modula (3+3) - Banquise bele boje - koristi se sa armaturom 45B66 - u kompletu sa maskama 45PY033... 6 modules (3+3) banquise white box to be used with 45B66 frames and 45PY003.. front plates	1	15
45SY6AO	6 modula (3+3) - srebrne mat boje - koristi se sa armaturom 45B66 - u kompletu sa maskama 45PY033... 6 modules (3+3) Matt silver box to be used with 45B66 frames and 45PY003.. front plates	1	15
45SY10	10 modula (5+5) - Banquise bele boje - koristi se sa armaturom 45760/10 - u kompletu sa maskama 45PY010... 10 modules (5+5) banquise white box to be used with 45760/10 frames and 45PY010.. front plates	1	6
45SY20	20 modula (5+5+5+5) - Banquise bele boje - koristi se sa armaturom 45760/20 - u kompletu sa maskama 45PY020..., 45PY10DIN... 20 modules (5+5+5+5) banquise white box to be used with/20 45760 frames and 45PY020..., 45PY10DIN front plates	1	5



45SY6



45SY10



45SY20

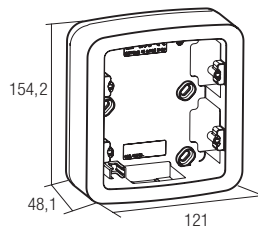

45SY6

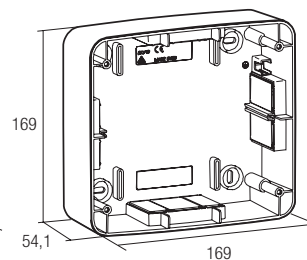

45SY10

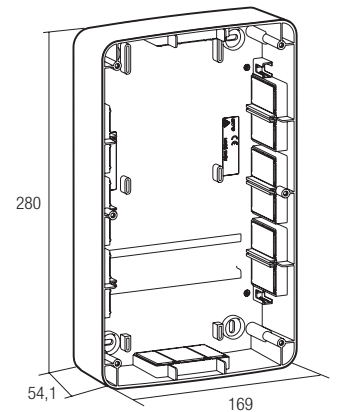

45SY20



Za raspoloživost kontaktirajte Ave distributere
For availability please contact sales dept.



Dostupni dok se ne rasprodaju zalihe
Available until stock out



Proizvod 2 modula pogodan i za okrugle kutije
2 modules product suitable for round box



Proizvod za pravougaone kutije britanskog standarda
Product for British standard rectangular box



Proizvod za izvoz
For Export only

Nadgradne kutije za maske "Ral 45" i "Zama 45" - Sistem 45

Wall mounted boxes for "Ral 45" and "Zama 45" front plates - System 45

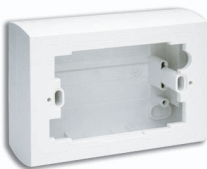
	Kod	Code	Opis	Description	Info	€
 45SA03	45SA03		Nadgradna kutija za 3 modula Banquise bele boje (RAL 9016)	Nadgradna kutija za 3 modula Banquise bele boje (RAL 9016) - koristi se sa armaturama za 3 modula - u kompletu sa maskama 45P93... ili 45P03... 3 modules white box to be used with System 45 3 modules frames to be completed with 45P93... or 45P03... front plates	1	16
	45SA03GN		Nadgradna kutija za 3 modula Noir sive boje	Nadgradna kutija za 3 modula Noir sive boje - koristi se sa armaturama za 3 modula - u kompletu sa maskama 45P93... ili 45P03... 3 modules Noir grey box to be used with System 45 3 modules frames to be completed with 45P93... or 45P03... front plates	1	16

411

Primer upotrebe Application example



Postavljanje nadgradne kutije (45SA03) za 3 modula Sistema 45 u kompletu sa maskom Zama i podnim kanalom
 Application for finishing box (45SA03) 3 gang of system 45, it can be combined with plate ZAMA and skirting trunking



Primena samonosećih kutija (44QC01 i 44QC03) za 1 i 3 modula Sistema44 sa mini-kanalicama
 Application for self-supporting boxes (44QC01 e 44QC03) 1 or 3 gang of system 44 with mini trunking

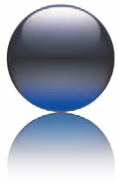

Kućišta za kanalice i mini-kanalice

Enclosures for Trunkings and Mini Trunkings

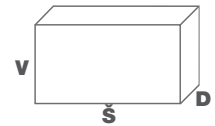

IP40 - Multifunkcionalna nadgradna kutija
IP40 - Enclosures

412



53SA05



53SA12

Kod	Code	Opis	Description	Info	€
53SA05		Multifunkcionalna nadgradna kutija RAL 7035 sive boje, koristi se sa poklopcem 53T05..	RAL 7035 box to be used with cover 53T05...	1	8
53SA05BG		Multifunkcionalna nadgradna kutija Banquise bele boje, koristi se sa poklopcem 53T05..	Banquise white box to be used with cover 53T05...	1	8
53SA12		Multifunkcionalna nadgradna kutija RAL 7035 sive boje, koristi se sa poklopcem 53T12..	RAL 7035 box to be used with cover 53T12...	1	5

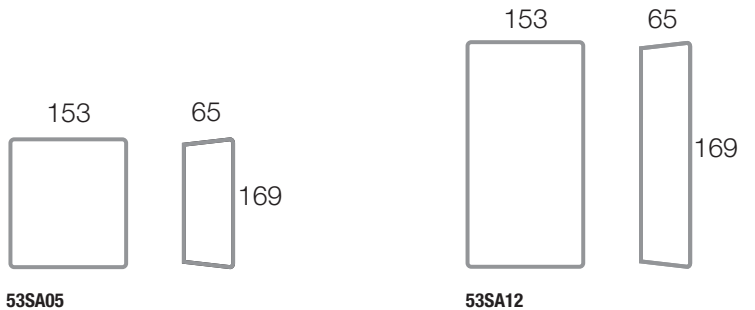

Način upotrebe *Instructions*



Urezan šablon za otvaranje dna u slučaju pokrivanja postojećih ugradnih kutija
Pre-cutting for covering existing boxes



Ležište za tamper mikroprekidač
Seat for anti-removal micro-switch



Za raspoloživost kontaktirajte
 Ave distributere
 For availability please contact
 sales dept.



Dostupni dok se ne
 rasprodaju zalihe
 Available until stock out



Proizvod 2 modula
 pogodan i za okrugle kutije
 2 modules product suitable
 for round box



Proizvod za pravougaone
 kutije britanskog standarda
 Product for British standard
 rectangular box





Proizvod za
 izvoz
 For Export
 only

Nadgradne razvodne table

Wall Mounted Consumer Units





IP40 - Nadgradne razvodne table - sive boje RAL 7035 IP40 - Enclosures - RAL 7035 grey

	Kod Code	Opis Description	Info	€	413
	53542	Kućište za 1-2 mod. DIN - dimenzije (V Š D): 44x126x59 mm Enclosure for 1-2 DIN mod. - dimensions (L H D): 44x126x59 mm		1	25
	Q4004	Nadgradna razvodna tabla za 4+1/2 mod. DIN dimenzije (V Š D): 106x150x80 mm 4+1/2 DIN mod. enclosure dimensions (L H D): 106x150x80 mm		1	30
Q4004	Q4008	Nadgradna razvodna tabla za 8+1 mod. DIN dimenzije (V Š D): 216x180x86 mm 8+1 DIN mod. enclosure dimensions (L H D): 216x180x86 mm		1	14
	Q4008P	Nadgradna razvodna tabla sa vratima za 8+1 mod. DIN dimenzije (V Š D): 216x180x100 mm Enclosure with door - 8+1 DIN mod. dimensions (L H D): 216x180x100 mm	*14W	1	14
Q4012P	Q4012P	Nadgradna razvodna tabla sa vratima za 12+1 modula DIN dimenzije (V Š D): 298x230x100 mm Enclosure with door - 12+1 DIN mod. dimensions (L H D): 298x230x100 mm	*19W	1	7

*Pde = maksimalna dozvoljena disipacija *Pde = maximum capability to dissipate power

IP55 - Nadgradne razvodne table - sive boje RAL 7035

IP55 - Enclosures - RAL 7035 grey

	Kod Code	Opis Description	Info	€
	Q5505	Nadgradna razvodna tabla za 5 mod. DIN - dimenzije (V Š D): 158x185x100 mm 5 DIN mod. enclosure - dimensions (L H D): 158x185x100 mm		1 15
	Q5506	Nadgradna razvodna tabla za 6 mod. DIN - dimenzije (V Š D): 185x215x116 mm 6 DIN mod. enclosure - dimensions (L H D): 185x215x116 mm		1 1
	Q5508	Nadgradna razvodna tabla za 8 mod. DIN - dimenzije (V Š D): 214x185x100 mm 8 DIN mod. enclosure - dimensions (L H D): 214x185x100 mm		1 10
Q5505	Q5512	Nadgradna razvodna tabla za 12 mod. DIN - dimenzije (V Š D): 315x215x116 mm 12 DIN mod. enclosure - dimensions (L H D): 315x215x116 mm		1 1
	Q5524	Nadgradna razvodna tabla za 24 (2x12) mod. DIN - dimenzije (V Š D): 305x420x145 mm 24 (2x12) DIN mod. enclosure - dimensions (L H D): 305x420x145 mm		1 1
	Q5536	Nadgradna razvodna tabla za 36 (3x12) mod. DIN - dimenzije (V Š D): 305x560x145 mm 36 (3x12) DIN mod. enclosure - dimensions (L H D): 305x560x145 mm		1 1
Q5512	Q5554	Nadgradna razvodna tabla za 54 (3x18) mod. DIN - dimenzije (V Š D): 410x560x149 mm 54 (3x18) DIN mod. enclosure - dimensions (L H D): 410x560x149 mm		1 1

Napomena: Nadgradne razvodne table mogu imati i metalnu bravicu sa ključem Q024 (Q5506, Q5512, Q5524, Q5536, Q5554) i Q025 (Q5505, Q5508).
N.B.: Accessorizable consumer units with metallic lock code Q024 (Q5506, Q5512, Q5524, Q5536, Q5554) and code Q025 (Q5505, Q5508).

IP55 - Nadgradno kućište za slučaj opasnosti IP55 - Emergency

	Kod Code	Opis Description	Info	€
	Q5505ER	Nadgradno kućište za slučaj opasnosti crvene boje RAL 3020 u kompletu sa DIN šinom - 5 mod. DIN lomljivo staklo - bravica sa metalnim ključem - dimenzije (V Š D): 157x185x100 mm RAL 3020 red emergency enclosure provided with DIN bar - 5 DIN mod. - breakable glass - lock with metallic key - dimensions (L H D): 157x185x100 mm	*16W	1 15
	Q5508ER	Nadgradno kućište za slučaj opasnosti crvene boje RAL 3020 u kompletu sa DIN šinom - 8 mod. DIN lomljivo staklo - bravica sa metalnim ključem - dimenzije (V Š D): 217x185x100 mm RAL 3020 red emergency enclosure provided with DIN bar - 8 DIN mod. - breakable glass - lock with metallic key - dimensions (L H D): 217x185x100 mm	*20W	1 10

* Pde = maksimalna dozvoljena disipacija *Pde = maximum capability to dissipate power

◇ Proizvod za kvadratnu kutiju
Product for British Standard
square box only

② Proizvod 1 modula koji se može postaviti u
okruglu kutiju sa drugim proizvodom 1 modula
1 module product installable in round box with
another 1 module device

☐ Min. pakovanje kom.
Min. Packaging pcs

☐ Stand. pakovanje kom.
Std. Packaging pcs

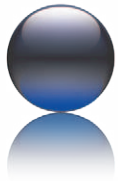

Nadgradne razvodne table

Wall Mounted Consumer Units

IP65 - Nadgradne razvodne table

IP65 - Enclosures

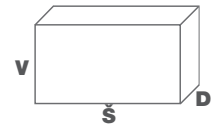

414



Q6536



Q6554

Kod	Code	Opis	Description	Info	€
Q6506		Nadgradna razvodna tabla za 6 mod. DIN - dimenzije (V Š D): 225x260x138 mm 6 DIN mod. enclosure - dimensions (L H D): 225x260x138 mm		* 14W	1 1
Q6508		Nadgradna razvodna tabla za 8 mod. DIN - dimenzije (V Š D): 260x260x138 mm 8 DIN mod. enclosure - dimensions (L H D): 260x260x138 mm		* 20W	1 1
Q6512		Nadgradna razvodna tabla za 12 mod. DIN - dimenzije (V Š D): 330x260x138 mm 12 DIN mod. enclosure - dimensions (L H D): 330x260x138 mm		* 29W	1 1
Q6524		Nadgradna razvodna tabla za 24 (2x12) mod. DIN - dimenzije (V Š D): 330x420x138 mm 24 (2x12) DIN mod. enclosure - dimensions (L H D): 330x420x138 mm		* 40W	1 1
Q6536		Nadgradna razvodna tabla za 36 (3x12) mod. DIN - dimenzije (V Š D): 330x580x138 mm 36 (3x12) DIN mod. enclosure - dimensions (L H D): 330x580x138 mm		* 55W	1 1
Q6554		Nadgradna razvodna tabla za 54 (3x18) mod. DIN - dimenzije (V Š D): 435x580x138 mm 54 (3x18) DIN mod. enclosure - dimensions (L H D): 435x580x138 mm		* 71W	1 1

*Pde = maksimalna dozvoljena disipacija *Pde = maximum capability to dissipate power

Tehničke karakteristike Technical Features

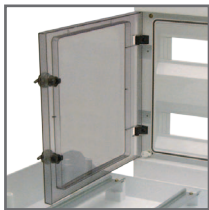

SIMETRIČNA I REVERZIBILNA VRATA, MOGU SE OTVORITI DO 180° STEPENI

SYMMETRIC AND REVERSIBLE DOOR, OPENING UP TO 180°

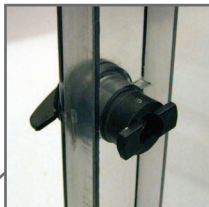

KLASIČNA BRAVA (SA KOJOM SE KUTIJA ISPORUČUJE) MOŽE SE ZAMENITI METALNOM BRAVICOM SA KLJUČEM

POSSIBILITY OF SUBSTITUTION OF TRADITIONAL LOCK (SUPPLIED) WITH METALLIC KEY

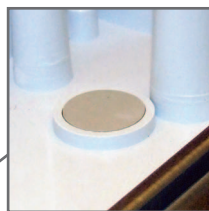

DUPLA IZOLACIJA KOJA SE POSTIŽE POSTAVLJANJEM ZAPTIVAKA KOJI SE STAVLJAJU PREKO ŠRAFOVA
DOUBLE ISOLATION OBTAINED BY MEANS OF SUPPLIED BLANK INSERTS.

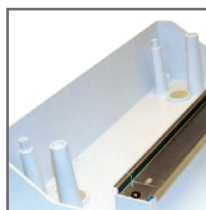

STUBIČI ZA FIKSIRANJE PRIKLJUČAKA ZA NULU/UZEMLJENJE

ARRANGED COLUMNS FOR CLIPS FIXING.



SILIKONSKI ZAPTIVAK KOJI SE POSTIŽE ODRŽAVANJE IP65 STEPENA ZAŠTITE
SILICON SEAL TO KEEP THE IP65 DEGREE

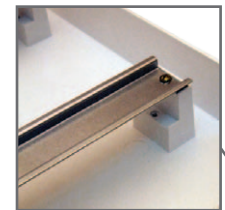

POSTAVLJANJE MODULARNIH DIN UREĐAJA VISINE OD 68MM DO 75MM.

APPLICATION OF DIN RAIL MODULAR DEVICES WITH HEIGHT FROM 68MM TO 75MM.



DVA ŠRAFA SA PLASTIČNIM DODATKOM ZA HERMETIČKO ZATVARANJE OTVORA

TWO SCREWS EQUIPPED WITH A PLASTIC DEVICE FOR SEALING OPERATION.



Za raspoloživost kontaktirajte Ave distributere
For availability please contact sales dept.



Dostupni dok se ne rasprodaju zalihe
Available until stock out



Proizvod 2 modula pogodan i za okrugle kutije
2 modules product suitable for round box



Proizvod za pravougaone kutije britanskog standarda
Product for British standard rectangular box





Proizvod za izvoz
For Export only

Dodatna oprema za razvodne table

Accessories for Consumer Units





Metalne brave Metal locks

	Kod Code	Opis Description	Info	€
 Q65SCM	Q65SCM	Metalna bravica sa ključem za razvodne table Q6506, Q6508, Q6512, Q6524, Q6536, Q6554 <i>Metal lock with key for Q6506, Q6508, Q6512, Q6524, Q6536, Q6554 enclosures</i>	1	1
	Q024	Metalna bravica sa ključem za razvodne table Q5506, Q5512, Q5524, Q5536, Q5554 <i>Metal lock with key for Q5506, Q5512, Q5524, Q5536, Q5554 enclosures</i>	1	1
	Q025	Metalna bravica sa ključem za razvodne table Q5505 e Q5508 <i>Metal lock with key for Q5505 e Q5508 series enclosures</i>	1	1
	Q40SCM	Metalna bravica sa ključem za razvodne table: Q4008P - Q4012P <i>Security metal lock with key for enclosures: Q4008P - Q4012P</i>	1	1
 Q024				

415



Sabirnice Terminal bars

	Kod Code	Opis Description	Info	€
 Q65M6	Q65M6	Sabirnica 7X1,5-16mm ² In 100A Ue 230/400V za razvodnu tablu IP65 Q6506 <i>Terminal bar 7X1,5-16mm² In 100A Ue 230/400V for IP65 enclosure Q6506</i>	1	1
	Q65M8	Sabirnica 9X1,5-16mm ² In 100A Ue 230/400V za razvodnu tablu IP65 Q6508 <i>Terminal bar 9X1,5-16mm² In 100A Ue 230/400V for IP65 enclosure Q6508</i>	1	1
	Q65M12	Sabirnica 13X1,5-16mm ² In 100A Ue 230/400V za razvodne table IP65 Q6512, Q6524 i Q6536 <i>Terminal bar 13X1,5-16mm² In 100A Ue 230/400V for IP65 enclosures Q6512, Q6524 and Q6536</i>	1	1
	Q65M18	Sabirnica 16x(1,5-16)+3x(6-25)mm ² In 100A Ue 230/400V za razvodnu tablu IP65 Q6554 <i>Terminal bar 16x(1,5-16)+3x(6-25)mm² In 100A Ue 230/400V for IP65 enclosure Q6554</i>	1	1
 Q65M18				

Slepi moduli Blank Inserts

	Kod Code	Opis Description	Info	€
 5300	5300	Slepi moduli koji se mogu seći za razvodne table 53Txxyy <i>Blank insert for 53Txxyy consumer units</i>	10	10
	53CF1	Slepi modul 1 mod. DIN za kačenje na DIN šinu - za razvodne table Q55xx <i>1 DIN mod. blank insert to be clipped on DIN rail - for Q55xx consumer units</i>	10	10
	045	Slepi modul, traka visine 45 mm - za razvodne table 53Txxyy - dužina 500 mm <i>Blank strip height 45 mm - for 53Txxyy consumer units - length 500 mm</i>	1	1
 53CF1				

Adapter za montažu DIN šine EN 50022 Adapters for DIN EN 50022 rail

	Kod Code	Opis Description	Info	€
 53/44	53/44	Adapter za montažu 1 modula S44 na DIN šinu EN 50022 - zauzima 1,5 modul DIN od 17,5 mm - boja RAL7035 <i>1 module adapter to install S44 on DIN EN 50022 rail - it takes 1,5 DIN modules of 17,5 mm - RAL7035 colour</i>	20	20
	53/44/2	Adapter za montažu 2 modula S44 na DIN šinu EN 50022 - zauzima 3 modula DIN od 17,5 mm - boja RAL7035 <i>2 modules adapter to install S44 on DIN EN 50022 rail - it takes 3 DIN modules of 17,5 mm - RAL7035 colour</i>	8	8
 53/44/2	53.45	Adapter za montažu 1 modula S45 na DIN šinu EN 50022 - zauzima 1,5 modul DIN od 17,5 mm - boja RAL7035 <i>1 module adapter to install S44 on DIN EN 50022 rail - it takes 1,5 DIN modules of 17,5 mm - RAL7035 colour</i>	20	20
	53.45/2	Adapter za montažu 2 modula S45 na DIN šinu EN 50022 - zauzima 3 modula DIN od 17,5 mm - boja RAL7035 <i>2 modules adapter to install S44 on DIN EN 50022 rail - it takes 3 DIN modules of 17,5 mm - RAL7035 colour</i>	8	8

Kutije, kućišta i razvodne table
Boxes, Enclosure and Consumer Units

◇ Proizvod za kvadratnu kutiju
Product for British Standard square box only

② Proizvod 1 modula koji se može postaviti u okruglu kutiju sa drugim proizvodom 1 modula
1 module product installable in round box with another 1 module device

□ Mln. pakovanje kom.
Min. Packaging pcs

□ Stand. pakovanje kom.
Std. Packaging pcs

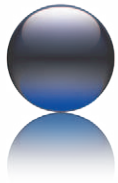

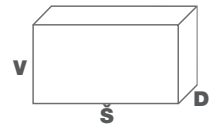

Dodatna oprema za razvodne table

Accessories for Consumer Units



Bus šina za povezivanje Connection bus bars

416

	Kod Code	Opis Description	Info	€
 0111	0111	Bus šina za povezivanje 13 jednopolnih automatskih prekidača - dužina 227,5 mm - prečnik 10 mm - koristi se sa: 5331Nx.. / 5361..x.. 13 DIN modules busbar – 1P – Lenght 227,5 mm – Section 10mm ² To be used with: 5331Nx.. / 5361..x..	2	10 10
 0112	0112	Bus šina za povezivanje 6 dvopolnih automatskih osigurača - dužina 210 mm - prečnik 10 mm - koristi se sa: 53451NCx.. / 53452Cx.. / 5362..x.. / 53242x.. 6 DIN modules busbar – 2P – Lenght 210 mm – Section 10mm ² To be used with: 53451NCx.. / 53452Cx.. / 5362..x.. / 53242x..	2	10 10

IP55 - Razvodna kutija za kampovanje - siva RAL 7035

IP55 - Distribution box for camping - RAL 7035 grey



	Kod Code	Opis Description	Info	€
 BC510	BC510	Nosač razvodne kutije za kampovanje otporan na udarce - dimenzije (V Ø): 1000x80 mm Impact resistant PVC pole - dimensions (H Ø): 1000x80 mm		1 1
	BC511	Pocinkovana pločica za fiksiranje nosača na pod - dimenzije (V Š D): 220x100x220 mm Zinc coated steel base for floor installation - dimensions (L H D): 220x100x220 mm		1 1

Dodatna oprema za instalaciju

Installation accessories

Noseće šine, U nosači i heksagonalni razdelnici

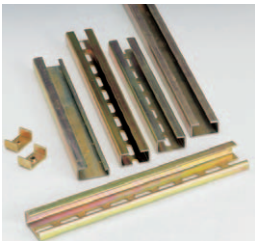
Support rails, U brackets and Hexagonal spacers

	Kod Code	Opis Description	Info	€
	UBP1011	Šraf za noseće šine - M4 Nut for support rail - M4		50 50
	UBP1013	Šraf za noseće šine - M6 Nut for support rail - M6		50 50
	UBP1101	Noseće šine 32x9x15 mm - EN50.035 - dužina 2000 mm Support rail 32x9x15 mm - EN50.035 - length 2000 mm		5 5
	0353	Šina za postavljanje DIN modula pored CEE 17 utičnica Adapter to install DIN modules and CEE 17 sockets side by side		20 20
	UBC1123	Bakarna šina – 6 x 6 mm – L = 2 Mt. Copper bar – 6 x 6 mm – L = 2 Mt.		5 5
	UBC1221	Izolator za blokiranje bakarne šine – Vite M6 x 25 mm. DIN spacer insulator, crew M6 x 25 mm.		50 50
	UBE1231	Pocinkovani heksagonalni razdelnik za šrafove i biksne M5 - dužina 50 mm - širina 8 mm Zinc coated hexagonal spacer for M5 screws and bolts. Lenght 50 mm - width 8 mm		50 50
	UBE1235	Pocinkovani heksagonalni razdelnik za šrafove i biksne M6 - dužina 50 mm - širina 10 mm Zinc coated hexagonal spacer for M6 screws and bolts. Lenght 50 mm - width 10 mm		50 50



Za raspoloživost kontaktirajte Ave distributere
For availability please contact sales dept.



Dostupni dok se ne rasprodaju zalihe
Available until stock out



Proizvod 2 modula pogodan i za okrugle kutije
2 modules product suitable for round box



Proizvod za pravougaone kutije britanskog standarda
Product for British standard rectangular box



Proizvod za izvoz
For Export only