



DomusAir - Stambena ventilacija

DomusAir - Residential ventilation

Aksijalni ventilatori "ELICAL TOP" Axial fans "ELICAL TOP"

18



VNS100
VNS100T
VNS100HT



Opis

Description

Info



VNS100

Aksijalni ventilator Ø100mm - motor sa kugličnim ležajevima (dugog veka trajanja) - montira se u kupatilu, toaletu i malim prostorijama
Osnovni model
Axial fan Ø100mm - ball bearing motor (long life)
- for installation in bathrooms, toilets and small living areas
Basic version



1 1

VNS100T

Aksijalni ventilator Ø100mm - motor sa kugličnim ležajevima (dugog veka trajanja) - montira se u kupatilu, toaletu i malim prostorijama
Model sa tajmerom
Axial fan Ø100mm - ball bearing motor (long life)
- for installation in bathrooms, toilets and small living areas
Timer version



1 1

VNS100HT

Aksijalni ventilator Ø100mm - motor sa kugličnim ležajevima (dugog veka trajanja) - montira se u kupatilu, toaletu i malim prostorijama
Model sa senzorom vlažnosti vazduha & tajmerom
Axial fan Ø100mm - ball bearing motor (long life)
- for installation in bathrooms, toilets and small living areas
Humidistat & timer version



1 1



VNS120
VNS120T
VNS120HT



VNS120

Aksijalni ventilator Ø120mm - motor sa kugličnim ležajevima (dugog veka trajanja) - montira se u kupatilu, toaletu i malim/srednjim prostorijama - Osnovni model
Axial fan Ø120mm - ball bearing motor (long life)
- for installation in bathrooms, toilets and small/medium living areas
Basic version



1 1

VNS120T

Aksijalni ventilator Ø120mm - motor sa kugličnim ležajevima (dugog veka trajanja) - montira se u kupatilu, toaletu i malim/srednjim prostorijama - Model sa tajmerom
Axial fan Ø120mm - ball bearing motor (long life)
- for installation in bathrooms, toilets and small/medium living areas
Timer version



1 1

VNS120HT

Aksijalni ventilator Ø120mm - motor sa kugličnim ležajevima (dugog veka trajanja) - montira se u kupatilu, toaletu i malim/srednjim prostorijama - Model sa senzorom vlažnosti vazduha & tajmerom
Axial fan Ø120mm - ball bearing motor (long life)
- for installation in bathrooms, toilets and small/medium living areas
Humidistat & timer version



1 1



VNS150
VNS150T
VNS150HT



VNS150

Aksijalni ventilator Ø150mm - motor sa kugličnim ležajevima (dugog veka trajanja) - montira se u kupatilu, toaletu i prostorijama srednje veličine - Osnovni model
Axial fan Ø150mm - ball bearing motor (long life)
- for installation in bathrooms, toilets and medium living areas
Basic version



1 1

VNS150T

Aksijalni ventilator Ø150mm - motor sa kugličnim ležajevima (dugog veka trajanja) - montira se u kupatilu, toaletu i prostorijama srednje veličine - Model sa tajmerom
Axial fan Ø150mm - ball bearing motor (long life)
- for installation in bathrooms, toilets and medium living areas
Timer version



1 1

VNS150HT

Aksijalni ventilator Ø150mm - motor sa kugličnim ležajevima (dugog veka trajanja) - montira se u kupatilu, toaletu i prostorijama srednje veličine - Model sa senzorom vlažnosti vazduha & tajmerom
Axial fan Ø150mm - ball bearing motor (long life)
- for installation in bathrooms, toilets and medium living areas
Humidistat & timer version



1 1

Napomena: za tehničke karakteristike i svojstva pogledajte na stranama 19-20-21

Note: for technical specifications and performance, please refer to page 19-20-21



Za raspoloživost kontaktirajte
Ave distributere
For availability please contact
sales dept.



Dostupni dok se ne
rasprodaju zalihe
Available until stock out



Min. pakovanje kom.
Min. Packaging pcs



Stand. pakovanje kom.
Std. Packaging pcs

Modeli Versions

Osnovni model

Ventilator se uključuje preko posebnog ON/OFF prekidača ili preko prekidača za svetlo.

Model sa tajmerom (sa odloženim isključivanjem)

Ovaj model poseduje programabilni tajmer koji se može podešavati u vremenskom intervalu od 1 do 25 minuta.

Način rada: nakon isključivanja, ventilator nastavlja da radi do isteka unapred podešenog perioda.

Model sa senzorom vlažnosti vazduha & tajmerom

Ovaj model poseduje strujno kolo sa senzorom za merenje vlažnosti, čije se prag intervencije može podešavati od 50% do 90% RV, kao i programabilni tajmer koji se može podešavati u vremenskom intervalu od 1 do 25 minuta.

Način rada: kada je relativna vlažnost vazduha viša/niša u odnosu na podešeni prag, ventilator se automatski uključuje/isključuje. Nakon isključivanja ventilator nastavlja da radi do isteka podešenog perioda.

Basic version

The fan is operated via a separate ON / OFF switch or via the light switch

Run-on timer version

The fan is equipped with a timer circuit adjustable from about 1 to 25 minutes.

Operation: after switching off, the fan continues to run for the pre-set period of time.

Humidistat & timer version

The fan is provided with an electronic circuit having a humidity sensor on board (adjustable from 50% to 95% RH) and timer, adjustable from about 1 to 25 minutes.

Operation: when the percentage of relative humidity is higher/lower than the pre-set threshold, the fan is automatically activated/de-activated.

After switching off, the fan continues to run for the pre-set period of time.

Karakteristike Features

- Asortiman aksijalnih ventilatora koji su idealni za provetranje kupatila, toaleta i malih/srednjih prostorija
- Na raspoloaganju su 3 veličine, Ø100-120-150mm prilagođene za montažu na standardne cevi.
- Projektovani su tako da ustajali vazduh odvođe u spoljašnju sredinu direktno ili preko kratkih cevi (dužine manje od 1,5m)
- Pogodni su za instalaciju na zid, tavanicu ili na prozor.
- Spoljašnje dimenzije su tako osmišljene da mogu da prekriju tragove montaže prethodnih ventilatora, ako postoje.
- Plastični delovi izrađeni su od ABS plastike visokog kvaliteta, koja je otporna na udarce i UV zračenja - bele boje RAL9010.
- Plastika se može reciklirati.
- Maska je elegantnog dizajna i minimalističkih linija; lako se kombinuje sa svakim tipom enterijera.
- Centralni aerodinamični luk sa specijalnim deflektorima na nosaču motora koji poboljšavaju učinak i stvaraju manje trenje pri protoku vazduha, čime se garantuje maksimalan akustični komfor.
- Dodatni poklopac koji se isporučuje sa ventilatorom. Sastoji se od prstena sa zadnje strane koji se može skinuti, sa plastičnim krilcima (koja sprečavaju prodor vazduha iz spoljašnje sredine kada je ventilator isključen)
- Prsten sa zadnje strane koji sprečava deformisanje otvora prilikom instalacije.
- Dodatni zaptivak za instalaciju na tavanice, na zahtev (str. 21)
- Dodatni pribor za staklo (str.42).
- Aerodinamični ventilator visoke efikasnosti, sa lopaticama tipa "winglet", odnosno sa krilcima zahvaljujući kojima se postiže bešuman rad i visok učinak.
- Induktivni monofazni motor sa termičkom zaštitom.
- Motor sa kugličnim ležajevima koji garantuje dug vek trajanja (Long Life - 30.000h) i koji ga čine pogodnim za hladne klimatske uslove.
- Pogodni su za kontinualan ili naizmeničan način rada.
- Stepen zaštite IPX4.
- Izrađeni su sa duplom izolacijom koja korisniku garantuje maksimalnu bezbednost.
- Ideal for air-extraction in bathroom, toilet and small/medium premises.
- Available in 3 diameters Ø100-120-150mm, suitable for connection to standard ducting.
- Suitable to extract stale air directly to the outside or through short length ducting (less than 1,5m).
- For wall/panel, ceiling and window installation.
- Perimetral size duly designed in order to cover, in case of replacement, the signs left on the wall by the previously installed fan.
- Plastic parts made of high quality ABS, shock-proof and UV resistant - RAL 9010 colour.
- Totally recyclable plastic components.
- Stylish bright finishing of the front cover to meet any modern interior design requirement.
- Aerodynamic-shaped inlet and deflectors to optimize the efficiency and the acoustic comfort.
- Back-draught shutter accessory supplied. It consists of a removable ring provided with a mylar flap, to prevent air flowing back into the room when the fan is off.
- Reinforcing rear plastic ring mounted at the spigot end to prevent it to get deformed during the installation.
- Gasket accessory for ceiling mounting on request (page 21).
- Window kit accessory on request (page 42).
- Highly efficient winglet-type impeller for high performance and top acoustic comfort.
- Single-phase induction motor with integral thermal protection.
- Ball bearing motor type to assure a longer fan life (30.000h): ideal for cold climates.
- Suitable for continuous and intermittent running.
- IP degree: X4
- Double insulated unit for the tenant's electrical safety.



DomusAir - Stambena ventilacija

DomusAir - Residential ventilation

Aksijalni ventilatori "ELICAL TOP"

Axial fans "ELICAL TOP"

20

Detalji Details

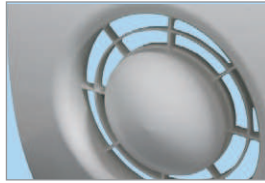

centralni aerodinamični luk
aerodynamic-shaped inlet

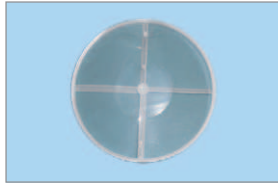

pribor za zatvaranje otvora
back-draught shutter accessory

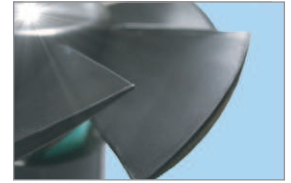

ventilator sa lopaticama "winglet"
winglet-type impeller

Performanse Performance

Kod Code	Model Model	Protok Air flow m ³ /h max	Statički pritisak Static pressure Pa max	Napajanje Power supply V~	Potrošnja Power W max	Zvučni pritisak Sound Pressure dB(A) @3m	Temp. prostorije Ambient temp. °C max	Oznaka Marking
VNS100	ELICAL TOP	88	27	220-240 50/60Hz	8	34	50	C
VNS100T	ELICAL TOP	88	27	220-240 50/60Hz	8	34	50	C
VNS100HT	ELICAL TOP	88	27	220-240 50/60Hz	8	34	50	C
VNS120	ELICAL TOP	175	40	220-240 50/60Hz	14	40	50	C
VNS120T	ELICAL TOP	175	40	220-240 50/60Hz	14	40	50	C
VNS120HT	ELICAL TOP	175	40	220-240 50/60Hz	14	40	50	C
VNS150	ELICAL TOP	330	59	220-240 50/60Hz	24	46	50	C
VNS150T	ELICAL TOP	330	59	220-240 50/60Hz	24	46	50	C
VNS150HT	ELICAL TOP	330	59	220-240 50/60Hz	24	46	50	C

Napomena ✓ vazdušne performanse izmerene prema standardu ISO 5801 na 230V 50Hz, gustina vazduha 1,2 Kg/m³
/Notes: air performance measured according to ISO 5801 at 230V 50Hz, air density 1,2 Kg/m³

✓ podaci izmereni u akreditovanoj laboratoriji TÜV Rheinland - data measured in TÜV Rheinland accredited laboratory

Krivulje Curves

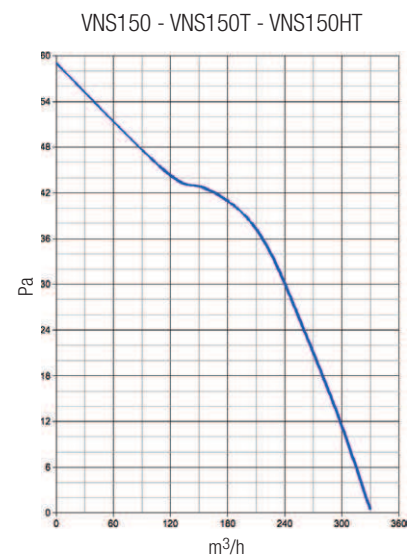
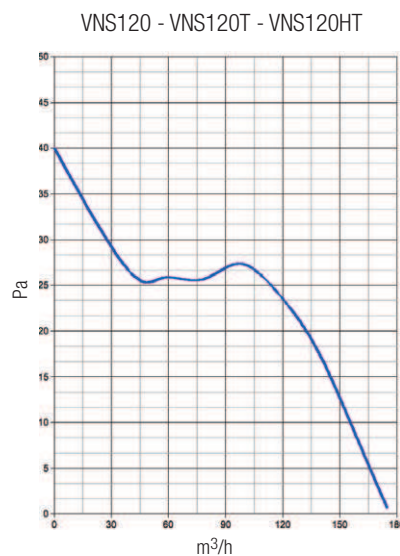
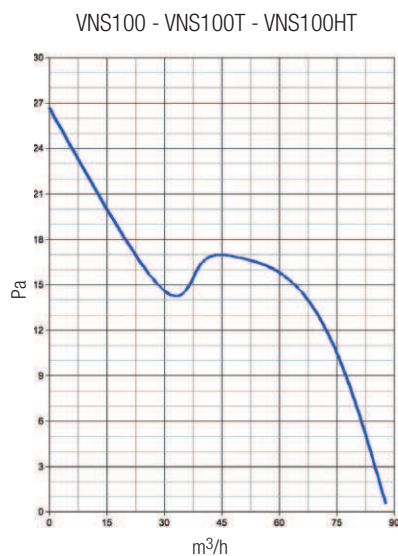

Za raspoloživost kontaktirajte
Ave distributere
For availability please contact
sales dept.



Dostupni dok se ne
rasprodaju zalihe
Available until stock out



Min. pakovanje kom.
Min. Packaging pcs

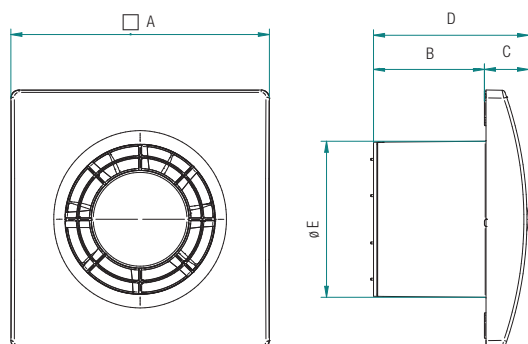

Stand. pakovanje kom.
Std. Packaging pcs

Dimenzije (u mm) Dimensions (mm)

Kod Code	A	B	C	D	ØE
VNS100 - VNS100T - VNS100HT	164	70	28	98	99
VNS120 - VNS120T - VNS120HT	184	81	27	108	119
VNS150 - VNS150T - VNS150HT	218	97	27	124	148

Instalacija Installation

Aksijalni ventilator predstavlja idealno rešenje za odvod značajne zapremine ustajalog vazduha direktno u spoljašnju sredinu. S obzirom da stvara nizak pritisak, on mora biti povezan na odvod odgovarajućeg prečnika i dužine manje od 1,5m.

Pogrešna instalacija može da ugrozi pravilan rad i/ili učinak ventilatora.

limited pressure, it must be connected to the appropriate diameter duct less than 1,5m long. Improper installation may result in an incorrect operation and/or decrease of the fan performance.

The axial fan is the ideal solution to extract significant volumes of stale air directly outside. Since it generates

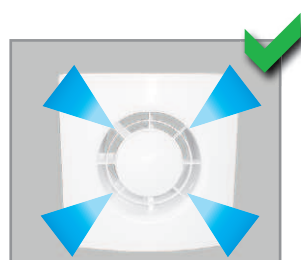

centralna aspiracija
central extraction



zid/panel
wall/panel

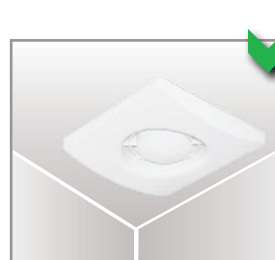

tavanica (pribor na zahtev)
ceiling (accessory on request)

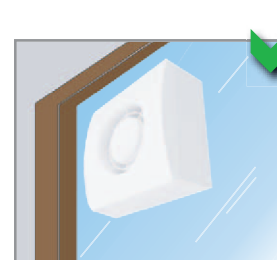

prozor (pribor na zahtev)
window (accessory on request)

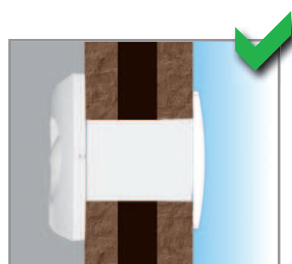
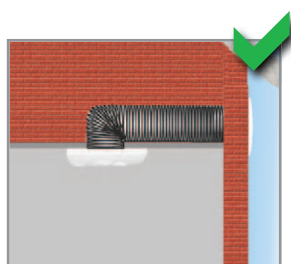

kratak odvodni kanal
short length of ducting

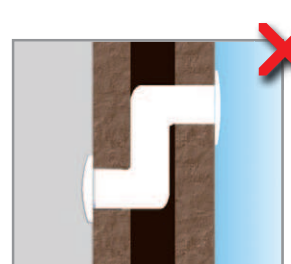
Pribor Accessories

441048M (Domus Touch)
442048M (Life Touch)
443048M (Allumia Touch)

Regulator brzine
Speed controller



441021 (Domus Touch)
442021 (Life Touch)
443021 (Allumia Touch)

Tajmer
Timer



441079 (Domus Touch)
442079 (Life Touch)
443079 (Allumia Touch)

Senzor vlažnosti vazduha
Humidistat



441068RL (Domus Touch)
442068RL (Life Touch)
443068RL (Allumia Touch)

IC detektor prisustva
PIR sensor

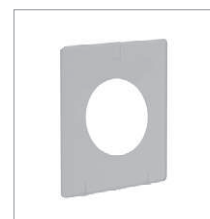

VNGS100 (Ø 100 mm)
VNGS120 (Ø 120 mm)
VNGS150 (Ø 150 mm)

Zaptivak za plafon
Ceiling gasket